

Miele Appliance Overview July 2024

PRODUCTS

INSPIRATION

RESOURCE CENTRE

- Ovens
- Coffee Systems
- Ranges
- Range Hoods
- Cooktops
- Hood Fans
- Dishwashers
- Refrigeration
- Laundry
- Professional
- Countertop Coffee Machines
- Floor Care

- Blog
- Editorial
- New Products
- Launching Soon

- Spec Sheets
- User Manual / Installation Guide
- CAD Data and BIM Data
- Multi- Residential Packages
- Certified Installation Program
- Miele Experience Centres
- Events / Cooking Classes
- Promotions
- Sustainability
- Customer Support

125 Years

ANNIVERSARY EDITION

- Table of Contents | 125 Edition
- Ovens
- Coffee System
- Dishwasher Panel
- Countertop Coffee Machines
- Floor Care
- CareCollection





Navigation Instructions

Click the Miele Logo at the top of every page to return to TOC and/or Cover page.

Click here on each page to access Miele's 'Specification Library'  Spec Sheets

Table of Contents Navigation

In T.O.C. click appliance or description to go to 'Section' or 'Category'



Click on appliance image to open product details page on Miele.ca

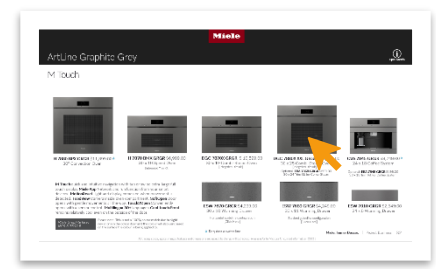
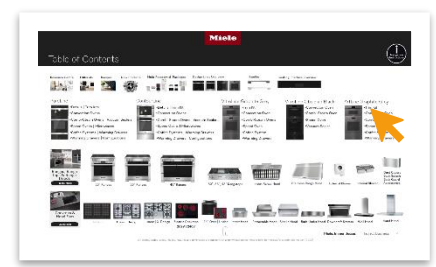
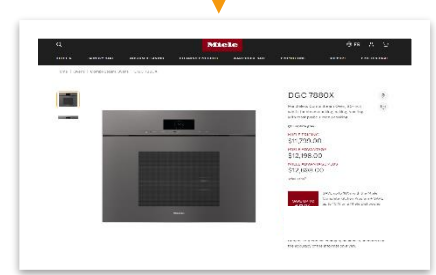

User Manuals

From product details page scroll down to "Downloads, CAD, & apps" click on "Manual"

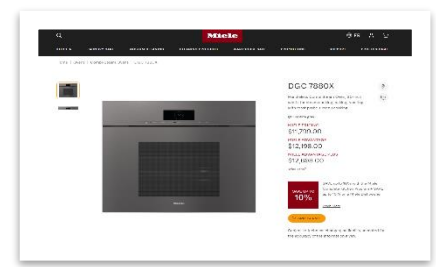

Scroll to bottom of page to downloads

Downloads, CAD, & apps

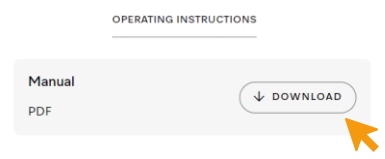

Manual Tip: Use the bookmark feature to quickly locate the Installation Specs within the appliance manual.



Alternate access to User Manuals

If the Miele User Manual is not available or a discontinued model, go to "Support" located on Miele.ca header and then select "Manuals & Specifications"

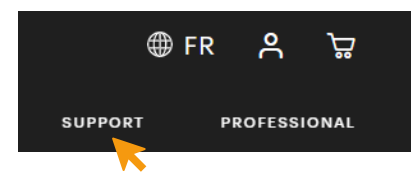

Select Manuals & Specifications then scroll to User Manuals

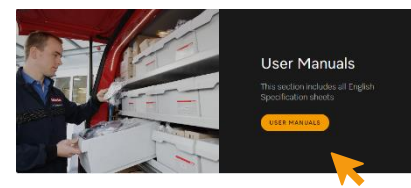

Enter Model Number and scroll down to see results

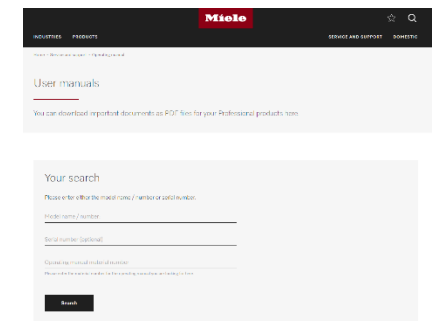

Specification Library

To access "Spec Sheets", go to "Support" located on Miele.ca header and then select "Manuals & Specifications"

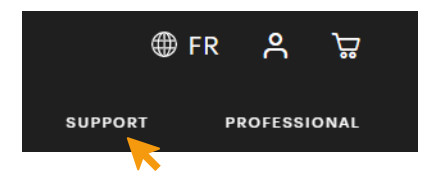

Select Manuals & Specifications then scroll to Spec Sheets

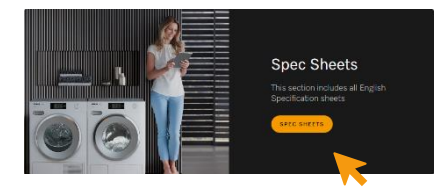

Spec sheets provide dimensions, cut-outs, electrical, ventilation, plumbing details etc.

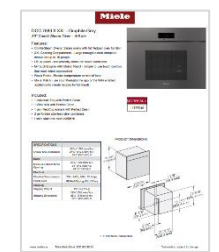

Table of Contents

- Resource Centre
- Editorials
- Recipes
- New Products
- Multi-Residential Packages
- Design Lines Overview
- Handles
- Cooking Interface Overview

PureLine

- Details | Trim Kits
- Convection Ovens
- Combi-Steam Ovens | Vacuum Sealers
- Speed Ovens | Microwaves
- Coffee Systems | Warming Drawers
- Warming Drawers | Configurations

ContourLine

- Details | Trim Kit
- Convection Ovens
- Combi-Steam Ovens | Vacuum Sealers
- Speed Ovens | Microwaves
- Coffee Systems | Warming Drawers
- Warming Drawers | Configurations

VitroLine Graphite Grey

- Trim Kit
- Convection Oven
- Combi-Steam Ovens
- Speed Oven
- Coffee System
- Warming Drawers

VitroLine Obsidian Black

- Convection Oven
- Combi-Steam Oven
- Speed Oven
- Vacuum Sealer

ArtLine Graphite Grey

- Trim Kit
- Convection Oven
- Combi-Steam Ovens
- Speed Oven
- Coffee System
- Warming Drawers

Ranges, Range tops & Range Hoods

[LEARN MORE](#)

30" Ranges

36" Ranges

48" Ranges

30", 36", 48" Rangetops

Insert Range Hood

Stainless Range Hood

External Blower

Internal Blower

Duct Covers Back Splash Back Guard Accessories

Cooktops & Hood Fans

[LEARN MORE](#)

Induction

Classic Design

Linear | X Design

Electric Cooktops
208V | 240V

24" Over | Under

Insert Hood

Retractable Hood

Slot-In Hood

Built-Under Hood

Downdraft System

Wall Hood

Island Hood



Table of Contents



Dishwashers

LEARN MORE

MasterCool Refrigeration

LEARN MORE

European Refrigeration

LEARN MORE





Laundry

LEARN MORE



Domestic Washer & Dryer

Professional

LEARN MORE





Countertop Coffee Machines

LEARN MORE

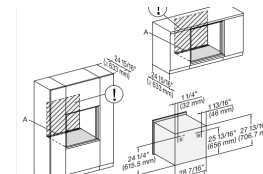

Floor Care

LEARN MORE

Resource Centre

LEARN MORE

Table of Contents | Special 125 Edition

- Convection Oven
- Combi-Steam Ovens
- Speed Oven
- Coffee System
- Warming Drawers
- Dishwasher Panel
- Countertop Coffee Machines
- Floor Care
- CareCollection



For over a century, Miele has set the standard for premium home appliances, continually pushing the boundaries of our commitment to Immer Besser – Forever Better. As we mark the significant occasion of Miele’s 125th anniversary, we are excited to introduce our exclusive Matte Black appliance series, a testament to our commitment to exceptional design and cutting-edge technology.



125
Years

Miele

ArtLine Obsidian Black Matte 125 Edition



M Touch



H 7880 BPX OBSW Matte \$11,899.00 
30" Convection Oven



H 7870 BMX OBSW Matte \$6,999.00
30 x 19 Speed Oven
[Integrated Trim Kit]



DGC 7870X OBSW Matte \$10,599.00
30 x 19 Combi-Steam Oven
[Integrated Trim Kit]



DGC 7880X XXL OBSW Matte \$11,799.00
30 x 25 Combi-Steam Oven
[Integrated Trim Kit]



CVA 7885 OBSW Matte \$8,749.00 
24 x 18 Coffee System
[Integrated Trim Kit]

Available Q4 2024



ESW 7680 OBSW Matte \$4,299.00
30 x 11 Warming Drawer

Stacked guideline configuration
[\[Click Here\]](#)



ESW 7670 OBSW Matte \$4,399.00
30 x 10 Warming Drawer

Horizontal guideline configuration
[\[Click Here\]](#)

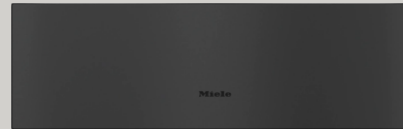

EVS 7670 OBSW Matte \$6,399.00
Vacuum Sealer

Horizontal guideline configuration
[\[Click Here\]](#)

 Requires a water line

Obsidian Matte Black

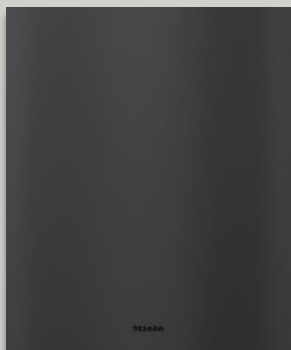

GFVi 713/77 125 OBSW Matte \$429.00
Dishwasher panel pares with
G 7966 SCVi knock 2 open dishwasher
Available Q3 2024



G 7966 SCVi K20 \$4,399.00
Fully-integrated knock to open dishwasher
Accepts GFVi 713/77 125 OBSW Matte panel



125
Years

Miele

Countertop Coffee Machines 125 Edition



Obsidian Matte Black



CM 5510 OBSW Matte \$2,049.99
Countertop Coffee Machine



CM 6360 OBSW Matte \$2,999.99
Countertop Coffee Machine



CM 7750 OBSW Matte \$5,999.99
Countertop Coffee Machine



125
Years

Miele

Floor Care 125 Gala Edition



Graphite Grey



Complete C3 125 Gala \$749.99
Canister vacuum

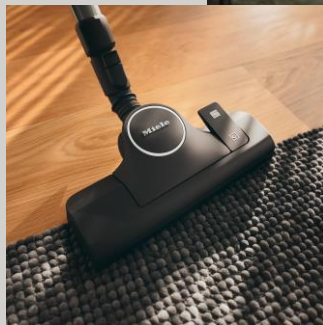

125
Years

Miele



Care Collection 125 Anniversary Edition



Ultra Color
Liquid Detergent 1.5L
\$25.99



FragranceFalcons
\$23.99



UltraPhase 1
\$34.99



UltraPhase 2
\$34.99



UltraPhase 6 pack
\$189.94

We are thrilled to introduce a limited-edition 125-year detergent to further elevate the laundry experience. Exclusively developed for Miele by perfumers from Provence, France, this luxurious fragrance is inspired by high-quality ingredients and made of soft floral notes and comforting scents with powdery and amber undertones mimicking the freshness of citrus.



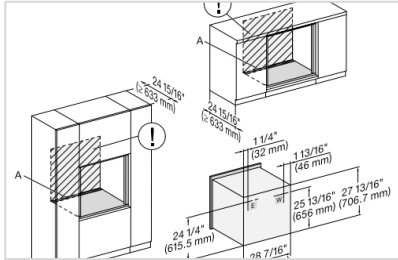

Spec Sheets

Download our Spec sheets for quick reference to dimensions, cut-outs, plumbing, electrical and ventilation requirements.

LEARN MORE

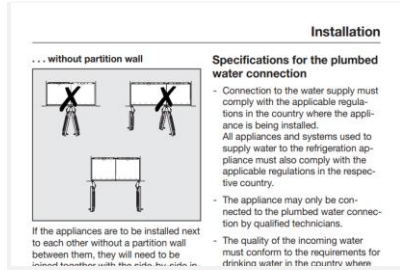

User Manual / Installation Guide

Simply enter the model number to download all current and discontinued models.

LEARN MORE



CAD Data and BIM Data

Central access to download all available CAD Blocks & BIM Files

LEARN MORE



Multi- Residential Packages

Discover our top recommended packages that will elevate your project.



LEARN MORE



Certified Installation Program

Feel secure knowing we handle your appliances every step of the way. With the installation of any Miele appliance a two-year warranty is included.

LEARN MORE



Miele Experience Centres

Experience Miele for yourself in our relaxed and inspiring environment. Enjoy a coffee/tea as we tour our innovative appliances for your project.

LEARN MORE



Events / Cooking Classes

Designed to inspire! We love to help you discover and learn more about our innovative appliances.

LEARN MORE



Promotions

Enjoy attractive innovations and promotions!

LEARN MORE



Sustainability

Our pledges for the planet. Learn about Miele's commitment to our sustainability pledges.

LEARN MORE

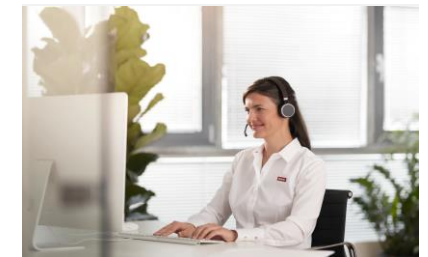

Customer Support

Support that is always there for you. Find the right services for your needs - we'll take care of the rest.

LEARN MORE

Miele

Blog

Your destination for culinary innovation and entertainment. Discover exciting new recipes, learn about new products and great ways to enjoy your Miele appliances.



Balsamic Roasted Beet, Orange & Chèvre Salad

A perfect combination for a delightful symphony of flavors in a refreshing, seasonal dish.

[Recipe](#)



[LEARN MORE](#)



Lemon-Garlic Marinated Chicken Breast

A simple dish that will deliver a level of tenderness and flavour that is nothing short of culinary perfection.

[Recipe](#)



[LEARN MORE](#)



Stacked Blueberry Pancakes

Savour the delightful fusion of sweet and tangy blueberries in every thick and airy pancake.

[Recipe](#)



[LEARN MORE](#)

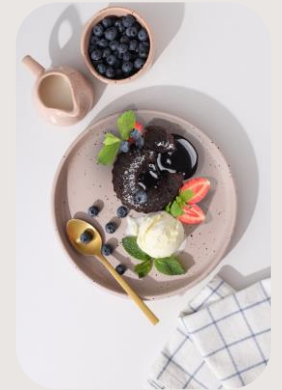

Molten Chocolate Lava Cake

Topped with a cloud of espresso whipped cream. Just the right amount for perfect decadence.

[Recipe](#)



[LEARN MORE](#)

Discover the Hyatt Family's Newly-Renovated Home featuring Miele Appliances

Toronto Life Magazine: Michael and Vanessa Hyatt

Modern family living takes center stage; a beautifully transformed space, elevated by Miele appliances.

[DISCOVER MORE](#)

New Products | Immer Besser

Always innovating to bring you the best in premium appliances.

Click on image to discover new products and features.

ANNIVERSARY EDITION



Artline, Matte Black

Convection Oven, Combi-Steam Oven, Speed Oven, Coffee System & Warming Drawers.

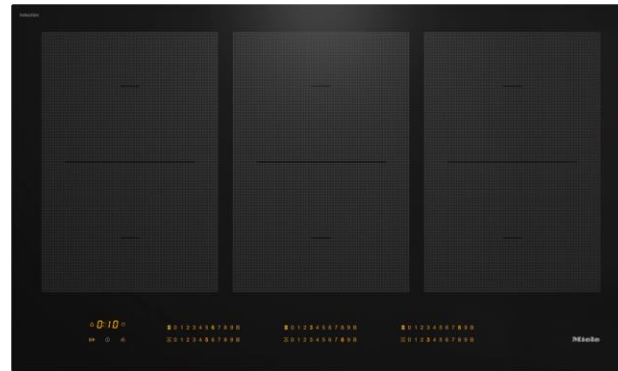

Frameless Induction Cooktops

30", 36", 42" SmartSelect & PowerFlex



30" Induction Range,

All electric with Direct Select interface



G 7000 Redesign Dishwashers + Pocket handle panels

Multi-Residential Packages

24 Inch Packages

Our purpose: building tomorrow
Together, we can shape a successful tomorrow.

CONTACT US



G 5056 SCVi



DAS 2620



H 2455 E
+ KM 6050



KFN 7734 D



G 5051 SCVi
ADA Compliant



DA 2360

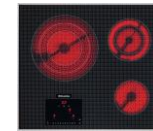

KM 5820



H 2455 B



KFN 7784 D

For over 20 years, Miele Canada's Project Business has been a proud and trusted supplier of premium appliances to the multi-residential sector, catering to esteemed developers, builders, architects, interior designers, and appliance agents. Discover why Miele is the most sought-after partner for premium multi-residential projects across the country.

Multi-Residential Packages

30 Inch Package



G 7156 SCVi



DAS 4720



M 2241 SC



H 2880 BP



KFN 9859 iDE



G 7366 SCVi



DA 2390



KM 7740 FR



H 7270 BM



H 7280 BP



KFN 9959 iDE

CONTACT US

For over 20 years, Miele Canada's Project Business has been a proud and trusted supplier of premium appliances to the multi-residential sector, catering to esteemed developers, builders, architects, interior designers, and appliance agents. Discover why Miele is the most sought-after partner for premium multi-residential projects across the country.

Generation 7000 Design Lines

PureLine



ContourLine



VitroLine

Graphite Grey



ArtLine

Graphite Grey



Obsidian Black



Matte Black



Colour Match Recommendations

Miele Obsidian black
RAL 9005

Miele Graphite Grey
NCS S 7502 B

Please note: These will not be a 100% colour match due to slight deviations in the colour itself and the colour will also vary based on the surface the colour is being applied to.

24" PureLine | VitroLine



DS 7000 PureLine
\$219.00



DS 7000 VitroLine GRGR
\$429.00

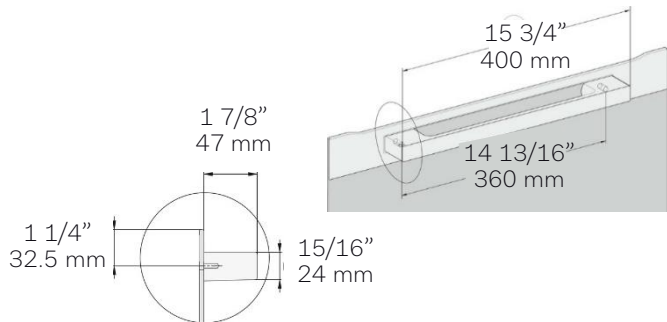

30" PureLine | VitroLine



DS 7808 PureLine
\$219.00



DS 7808 VitroLine GRGR
\$489.00



DS 7808 VitroLine OBSW
\$489.00

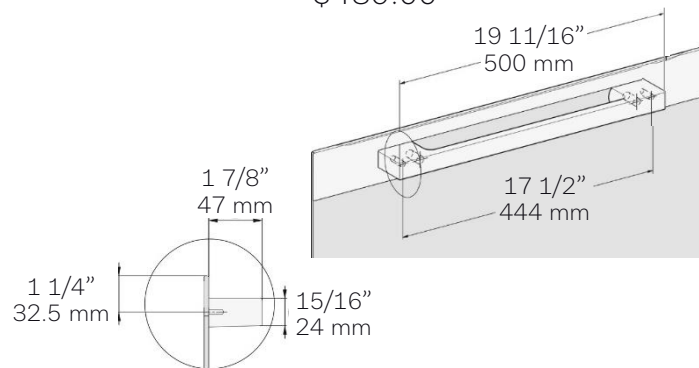

30" ContourLine



DS 7308 ContourLine
\$219.00



DS 7708 ContourLine Swiveling
\$319.00

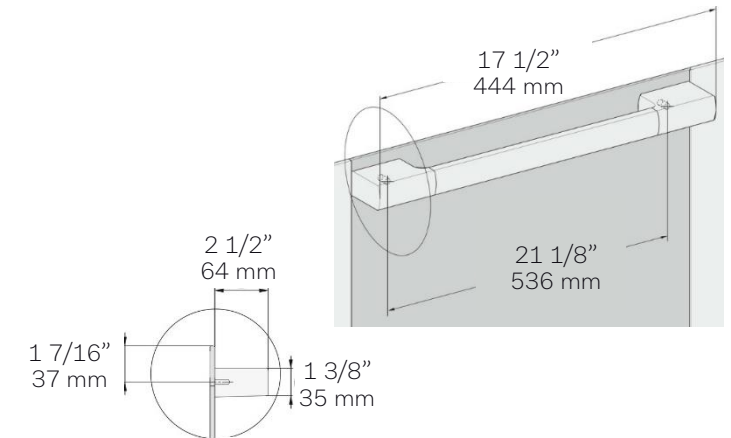

Generation 7000 Oven Interfaces

M Touch

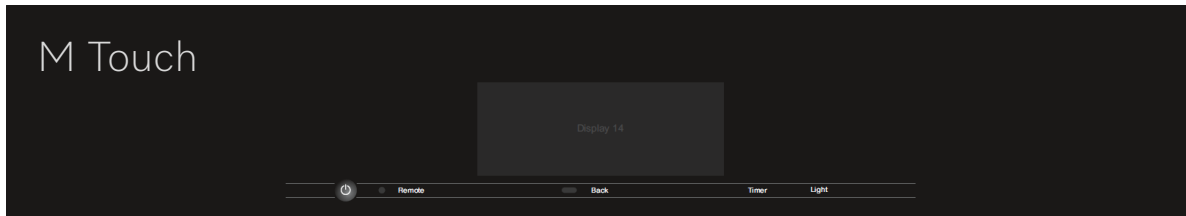

M Touch S

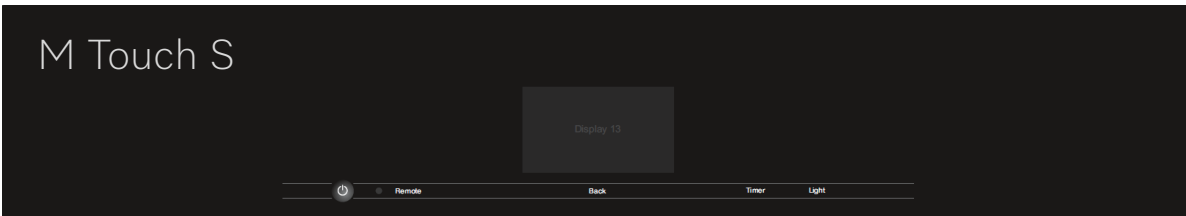

DirectSensor



DirectSensor S

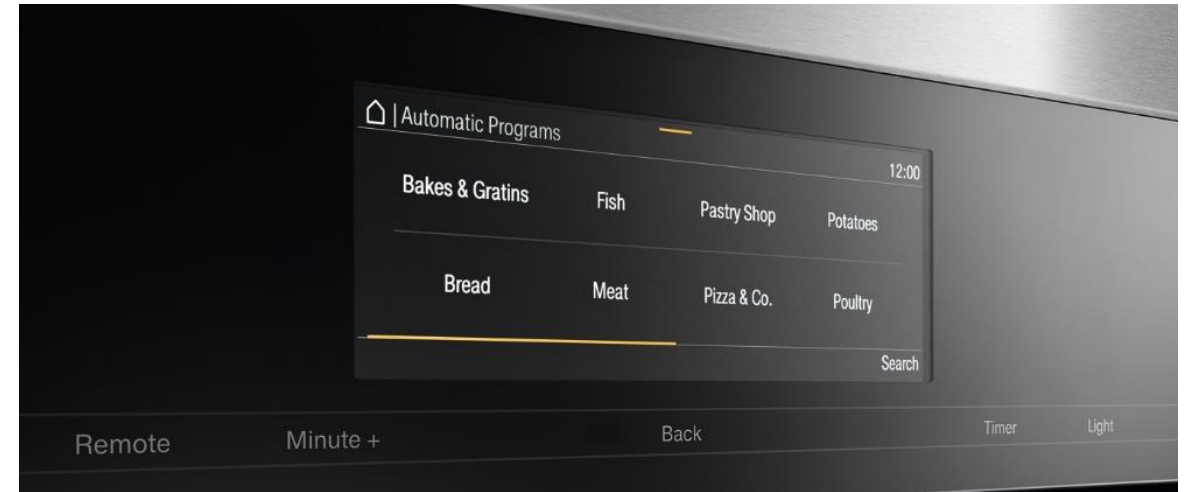
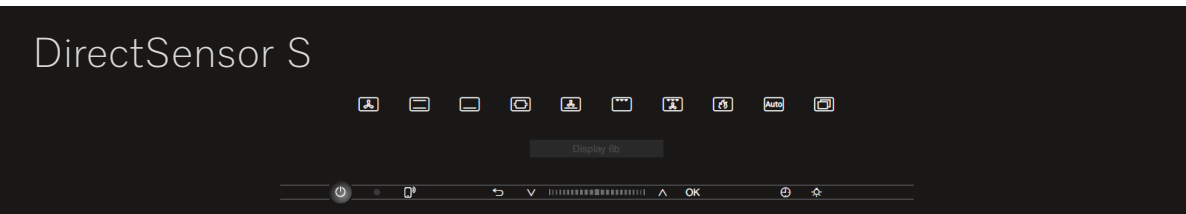

M Touch controls are both easy to operate and navigate. An intuitive swipe of the screen will quickly lead you to your desired selection with the touch of a fingertip.

DirectSensor controls enable options such as the operating mode to be selected directly. Further functions and settings are shown on the four-line, clear text display.

'S' Indicates smaller text display area

EasyControl

Only available in H 2880 BP
30" PureLine Convection oven



Combining Interfaces – M Touch and M Touch S are recommended together and DirectSensor, DirectSensor S and EasyControl are recommend together.



H 7880 BP

Trim Kit Options



EBA 7848 EDST/CLST \$599.00
30 x 18 Trim Kit



EBA 7868 EDST/CLST \$699.00
30 x 24 Trim Kit



EBA 2248 \$599.00
Microwave 30 x 18 Trim Kit in Black



PureLine offers a modern, contemporary appeal, with its solid handle, low-key stainless-steel trim and a glass front in obsidian black.



PureLine Convection Ovens

M Touch



H 7880 BP \$11,299.00 
30" Convection Oven

M Touch S



H 7680 BP \$9,549.00 
30" Convection Oven

DirectSensor S



H 7280 BP \$6,949.00
30" Convection Oven

EasyControl



H 2880 BP \$5,949.00
30" Convection Oven



M Touch S Oven **H 7660 BP** comes equipped with a water intake pipe for the steam injection system used with the Moisture Plus cooking program



H 7660 BP \$8,049.00
24" Convection Oven

Miele Built-In Ovens are installed independently of the cooktop and offer greater installation flexibility; for instance, they can be positioned at eye level for ultimate user convenience.

Available in PureLine only
Updates: TwinPower, Pyrolytic self-cleaning (racks must be removed), Retractable dials.
Not considered Generation 7000, as there are fewer programs, No Pyrofit racks, rails, runners, 2 racks, and no glider.
Intended for Multi-Residential Projects and entry-level only.

 Requires a water line | BP = Self Clean

PureLine Combination-Steam Ovens | Vacuum Sealers

M Touch



DGC 7870 \$10,049.00
30 x 19 Combi-Steam Oven
[Integrated Trim Kit]



DGC 7875 \$10,499.00 💧
30 x 19 Combi-Steam Oven
[Integrated Trim Kit]



DGC 7845 \$9,349.00 💧
24 x 18 Combi-Steam Oven

M Touch S



DGC 7640 \$8,649.00
24 x 18 Combi-Steam Oven

DirectSensor



DGC 7470 \$8,149.00
30 x 19 Combi-Steam Oven
[Integrated Trim Kit]



EVS 7010 [5 5/8] \$4,449.00
24 x 6 Vacuum Sealer



EVS 7670 [9 7/8] \$6,399.00
30 x 10 Vacuum Sealer



DGC 7880 XXL \$11,199.00
30 x 25 Combi-Steam Oven
[Integrated Trim Kit]



DGC 7865 XXL \$11,099.00 💧
24 x 24 Combi-Steam Oven

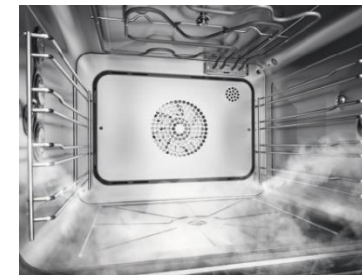

The 3-in-1 system for maximum variety
The Combi-Steam Oven gives you a steam oven, a convection oven, combined in to one appliance! Thanks to its DualSteam technology, you can cook food evenly and gently. And it really shows its versatility with combination cooking – combining moist and dry heat to ensure outstanding baking and roasting results.

30 x 18 Trim Kit **EBA 7848** \$549.00
30 x 24 Trim Kit **EBA 7868** \$699.00

Details [\[Click Here\]](#)

All DGC codes ending in (5) are plumbed | Requires a water line 💧

All pricing, codes, specs, images, features and dimensions are subject to change without notice. Always refer to Miele.ca for current information [2024]

PureLine Speed Ovens | Microwaves

M Touch



H 7870 BM \$6,449.00
30 x 19 Speed Oven
[Integrated Trim Kit]

M Touch S



H 7670 BM \$5,999.00
30 x 19 Speed Oven
[Integrated Trim Kit]



H 7640 BM \$5,349.00
24 x 18 Speed Oven

DirectSensor S



H 7270 BM \$5,249.00
30 x 19 Speed Oven
[Integrated Trim Kit]



H 7240 BM \$4,799.00
24 x 18 Speed Oven

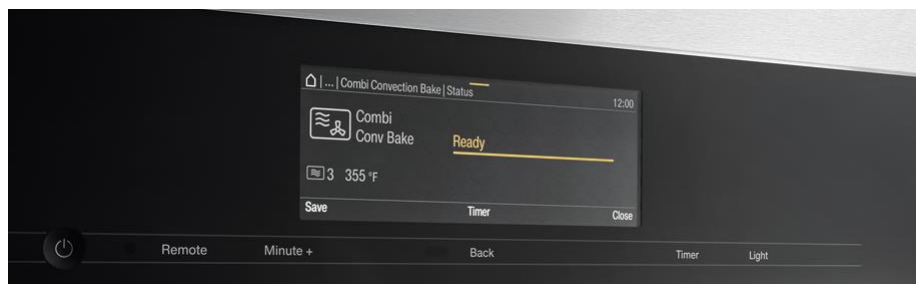

Speed Oven

The built-in Speed oven intelligently combines the benefits of two powerful appliances in either a 24" or 30" wide niche: This appliance is a convection oven with a wide variety of functions, at the same time as being a powerful microwave oven.



M 7240 TC \$3,149.00
24 x 18 Microwave
w/ Top Controls

30 x 18 Trim Kit [\[Click Here\]](#)
EBA 7848 \$599.00



M 2241 SC \$2,249.00
24 x 18 Microwave
w/ Side Controls

30 x 18 Trim Kit [\[Click Here\]](#)
EBA 2248 \$599.00

PureLine Built-In Coffee Systems | Warming Drawer

M Touch



CVA 7845 \$8,399.00
 24 x 18 Coffee System w/ DirectWater

Equipped with DirectWater (plumbed) but can be switched to manual tank fill if a waterline is not available.

DirectSensor



CVA 7440 \$6,049.00
 24 x 18 Coffee System



ESW 7010 [5 5/8] \$2,849.00
 24 x 6 Warming Drawer



EBA 7848 EDST/CLST \$599.00
 30 x 18 Trim Kit Option

Coffee Connoisseurs

Miele coffee beans are organically grown from the Arabica shrub and harvested in the highlands of south America. The beans are sourced from a fair-trade certified organic coffee cooperative, and then roasted and blended exclusively for Miele by a private German roaster. Available for purchase on 'Shop' Miele.ca
 Black Edition: Café Crema, Espresso, Decaf, One For All.



Requires a water line

Design Award
CVA 7845



Miele CVA 7845 Coffee is prepared freshly ground according to type and the beans that are selected from one of the three separate inner containers. Due to the demand-oriented automatic descaling and cleaning of milk lines and brewing unit via exchangeable cartridges, manual cleaning is no longer necessary. The illuminated, motor-driven spout adapts via sensor control to the cup heights and centrally dispenses the variety of hot beverages. The milk vessel can be inserted and removed in one movement from the front. All tanks and containers are optimized with an ergonomic design and functionality.
This model comes equipped with DirectWater (plumbed) and can be switched to manual tank fill if a waterline is not available.

PureLine Configurations with Warming Drawers & Vacuum Sealer

10" Warming Drawer | 10" Vacuum Sealer [Horizontal]



ESW 7670 [9 7/8] \$3,899.00
30 x 10 Warming Drawer



EVS 7670 [9 7/8] \$6,399.00
30 x 10 Vacuum Sealer

10" Warming drawer and 10" Vacuum Sealer is recommended below all 30 x 19 [18 7/8" tall] appliances and can be combined horizontally with all 30 x 19 lifestyle ovens. (Speed, Combi-steam and Coffee) 30 x 19 Models: DGC 7870, DGC 7875, DGC 7470, H 7870 BM, H 7670 BM, H 7270 BM. **Note: Shelf support is NOT required between the above listed models and the ESW 7670 or EVS 7660.**

11" Warming Drawer [Stacked]



ESW 7680 [10 7/8] \$3,899.00
30 x 11 Warming Drawer



11" Warming drawer is recommended at the bottom of any 30" wide vertical stack. **Note: Shelf support is required between a 30" Convection oven and ESW 7680 warming drawer.**

ESW 6380 FB Panel Ready optional [[Click Here](#)]

NOT RECOMMENDED:

ALL warming drawers and vacuum sealers placed below any 24 x 18 [17 15/16" tall] appliances with a 30" Trim kit will not line up horizontally with a 30" Convection oven. [See image A for 10" drawers and image B for 11" drawer.]

24 x 18 Models: DGC 7845, DGC 7640, H 7640 BM, H 7240 BM, CVA 7845, CVA 7440, M 7240 TC. [Exception M 2241 SC will work with 11" Drawer ESW 7680 as the interface has side controls with an all-black front]

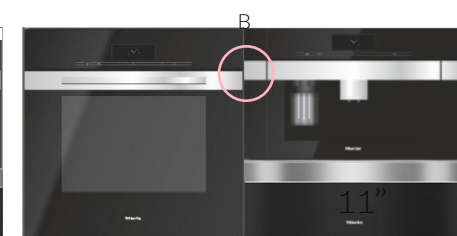
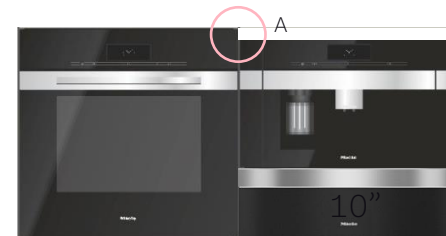

ContourLine



H 7780 BP

Trim Kit



EBA 2748 \$699.00

Optional Stainless 30 x 19 Trim Kit for
Microwave M 2241 SC

All ContourLine appliances are 30"W.
[Only exception is the 24 x 18 microwave seen above]



ContourLine offers a traditional to transitional appeal, with its ergonomic handle, stainless-steel framing and a glass front in obsidian black.



ContourLine Convection Ovens

M Touch



H 7780 BP \$11,299.00 
30" Convection Oven



H 7780 BP 2 \$16,899.00 
30 x 51 Double Convection Oven
(Moisture Plus feature in top oven only)

M Touch S



H 7580 BP \$9,549.00 
30" Convection Oven

DirectSensor S



H 7180 BP \$6,949.00
30" Convection Oven



Miele Built-In Ovens are installed independently of the cooktop and offer greater installation flexibility; for instance, they can be positioned at eye level for ultimate user convenience.

BP = Self Clean | Requires a water line 

ContourLine Combination-Steam Ovens

M Touch



DGC 7770 \$10,049.00
30 x 19 Combi-Steam Oven
[Integrated Trim Kit]



DGC 7775 \$10,499.00 
30 x 19 Combi-Steam Oven
[Integrated Trim Kit]

M Touch S



DGC 7580 \$10,399.00
30 x 25 Combi-Steam Oven
[Integrated Trim Kit]

DirectSensor



DGC 7370 \$8,149.00
30 x 19 Combi-Steam Oven
[Integrated Trim Kit]

The 3-in-1 system for maximum variety

The Combi-Steam Oven gives you a steam oven, a convection oven, combined in to one appliance! Thanks to its DualSteam technology, you can cook food evenly and gently. And it really shows its versatility with combination cooking – combining moist and dry heat to ensure outstanding baking and roasting results.



Automatic Programs

Success guaranteed - intelligent automatic programs. Effortlessly prepare 250 dishes with precision: Guaranteed results with fish, meat, vegetables, baked goods and more.

Menu Cooking

Everything ready at the same time - Automatic menu cooking A complete menu: Temperature, cooking duration and food sequence are automatically determined. Cooking made easy. (M Touch _ M Touch s)

ContourLine Speed Ovens | Microwave

M Touch



H 7770 BM \$6,449.00
30 x 19 Speed Oven
[Integrated Trim Kit]

M Touch S



H 7570 BM \$5,999.00
30 x 19 Speed Oven
[Integrated Trim Kit]

DirectSensor S



H 7170 BM \$5,249.00
30 x 19 Speed Oven
[Integrated Trim Kit]

EasyControl



M 2241 SC \$2,249.00
24 x 18 Microwave w/ Side Controls



Combination modes

For faster preparation, many dishes can be cooked much more quickly by combining a traditional operating mode and the microwave function, depending on the dish you could save up to 40% of your time.

Quick&Gentle

Inverter technology that applies power consistently through the cooking for even better results (speed oven)



EBA 2748 \$699.00
30 x 19 Trim Kit for Microwave

ContourLine Built-In Coffee Systems

M Touch



CVA 7775 \$9,599.00
 30 x 19 Coffee System w/ WaterDirect
 [Integrated Trim Kit]

Equipped with DirectWater (plumbed) but can be switched to manual tank fill if a waterline is not available.

DirectSensor



CVA 7370 \$7,299.00
 30 x 19 Coffee System
 [Integrated Trim Kit]



ESW 7570 [9 7/8] \$3,899.00
 30 x 10 Warming Drawer



Miele CVA 7775 Coffee is prepared freshly ground according to type and the beans that are selected from one of the three separate inner containers. Due to the demand-oriented automatic descaling and cleaning of milk lines and brewing unit via exchangeable cartridges, manual cleaning is no longer necessary. The illuminated, motor-driven spout adapts via sensor control to the cup heights and centrally dispenses the variety of hot beverages. The milk vessel can be inserted and removed in one movement from the front. All tanks and containers are optimized with an ergonomic design and functionality. **This model comes equipped with DirectWater (plumbed) and can be switched to manual tank fill if a waterline is not available.**



Coffee Connoisseurs

Miele coffee beans are organically grown from the Arabica shrub and harvested in the highlands of south America. The beans are sourced from a fair-trade certified organic coffee cooperative, and then roasted and blended exclusively for Miele by a private German roaster.

Available for purchase on 'Shop' Miele.ca
 Black Edition: Café Crema, Espresso, Decaf, One For All.

Requires a water line

ContourLine Configurations with Warming Drawers

10" Warming Drawer [Horizontal & Cube]



ESW 7570 [9 7/8] \$3,899.00
30 x 10 Warming Drawer

10" Warming drawer is recommended below all 18 7/8" tall appliance and can be combined horizontally with all 30" convection ovens. It works with ALL ContourLine Lifestyle appliances 30 x 19 - Speed (BM), Combi-Steam (DGC) Coffee system (CVA)

Note: Shelf support is NOT required between the above listed models and the ESW 7570.

Combining Interfaces – M Touch and M Touch S are recommended together and DirectSensor, DirectSensor S and EasyControl are recommend together.

11" Warming Drawer [Stacked]



ESW 7580 [10 3/4] \$3,899.00
30 x 11 Warming Drawer

11" Warming drawer is recommended at the bottom of any 30" wide vertical stack.
Note: Shelf support IS required between a 30" Convection oven and ESW 7580 warming drawer.

Panel Ready



ESW 6380 FB \$3,499.00
30 x 10 3/4 Warming Drawer

Recommended in a vertical stack with shelf support or independent of other appliances. Handle required.

VitroLine



Generation 7000 "VitroLine" is characterized by full glass fronts with a matching handle consisting of a high-quality metal carrier and a glass insert in graphite grey. This allows the VitroLine handle to blend harmoniously into the glass surface of the appliance. Miele-exclusive technological integrates features like; 'TasteControl', which automatically opens the oven door once cooking is finished to rapidly cool it and 'FoodView', an in-oven camera that can be followed on the Miele app, where users can also remotely adjust multiple functions.

VitroLine Graphite Grey [GRGR]

M Touch



H 7880 BP GRGR \$11,699.00
 30" Convection Oven



H 7870 BM GRGR \$6,799.00
 30 x 19 Speed Oven
 [Integrated Trim Kit]



DGC 7870 GRGR \$ 10,399.00
 30 x 19 Combination-Steam Oven
 [Integrated Trim Kit]



DGC 7860 XXL GRGR \$10,999.00
 24 x 24 Combination-Steam Oven
 Optional: **EBA 7868 GRGR** \$699.00
 30 x 24 Trim Kit for Comb-Steam



CVA 7845 GRGR \$8,749.00
 24 x 18 Coffee System
 Optional: **EBA 7848 GRGR** \$599.00
 30 x 18 Trim Kit for Coffee System

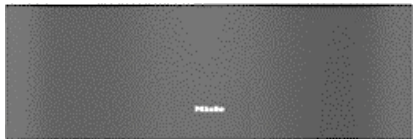

ESW 7680 GRGR \$4,249.00
 30 x 11 Warming Drawer

Stacked guideline configuration
 [Click Here]

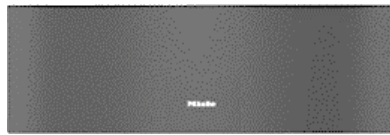

ESW 7670 GRGR \$4,299.00
 30 x 10 Warming Drawer

Horizontal guideline configuration
 [Click Here]

M Touch 30" Convection Oven: Quick and intuitive navigation with tap or swipe extra-large full-touch display **Miele App** Network and run function from your smart devices. **MotionReact** Light and display comes on when movement is detected. **FoodView** Camera inside oven compartment. **SoftOpen** Door opens with gentle movements all the way. **Multilingua 30+** languages **Cool-touch Front** remains relatively cool even on the outside of the door.



ESW 7010 GRGR \$2,849.00
 24 x 6 Warming Drawer

Requires a water line

VitroLine Obsidian Black



VitroLine underlines its reserved and integrating style with a handle design that is integrated with the appliance colour.



VitroLine Obsidian Black Collection

M Touch



H 7880 BP \$11,699.00 
30" Convection Oven



H 7870 BM \$6,799.00
30 x 19 Speed Oven
[Integrated Trim Kit]



DGC 7880 XXL \$ 10,399.00
30 x 24 Combination-Steam Oven



DGC 7870 \$ 10,399.00
30 x 19 Combination-Steam Oven
[Integrated Trim Kit]



ESW 7680 \$4,249.00
30 x 11 Warming Drawer

Stacked guideline configuration
[Click Here]



ESW 7670 \$4,299.00
30 x 10 Warming Drawer

Horizontal guideline configuration
[Click Here]



EVS 7670 \$6,399.00
30 x 10 Vacuum Sealer

Horizontal guideline configuration
[Click Here]

Requires a water line 



Vacuum Sealing means you can maintain the quality of your food, make it last longer, or prepare it for sous-vide cooking. you can easily vacuum seal leftovers and freeze them – the nutrients, flavor, and vitamins are retained much longer than with conventional freezing.



ArtLine

ArtLine with its minimalistic approach offers an intuitive touch operation, with a handleless design.

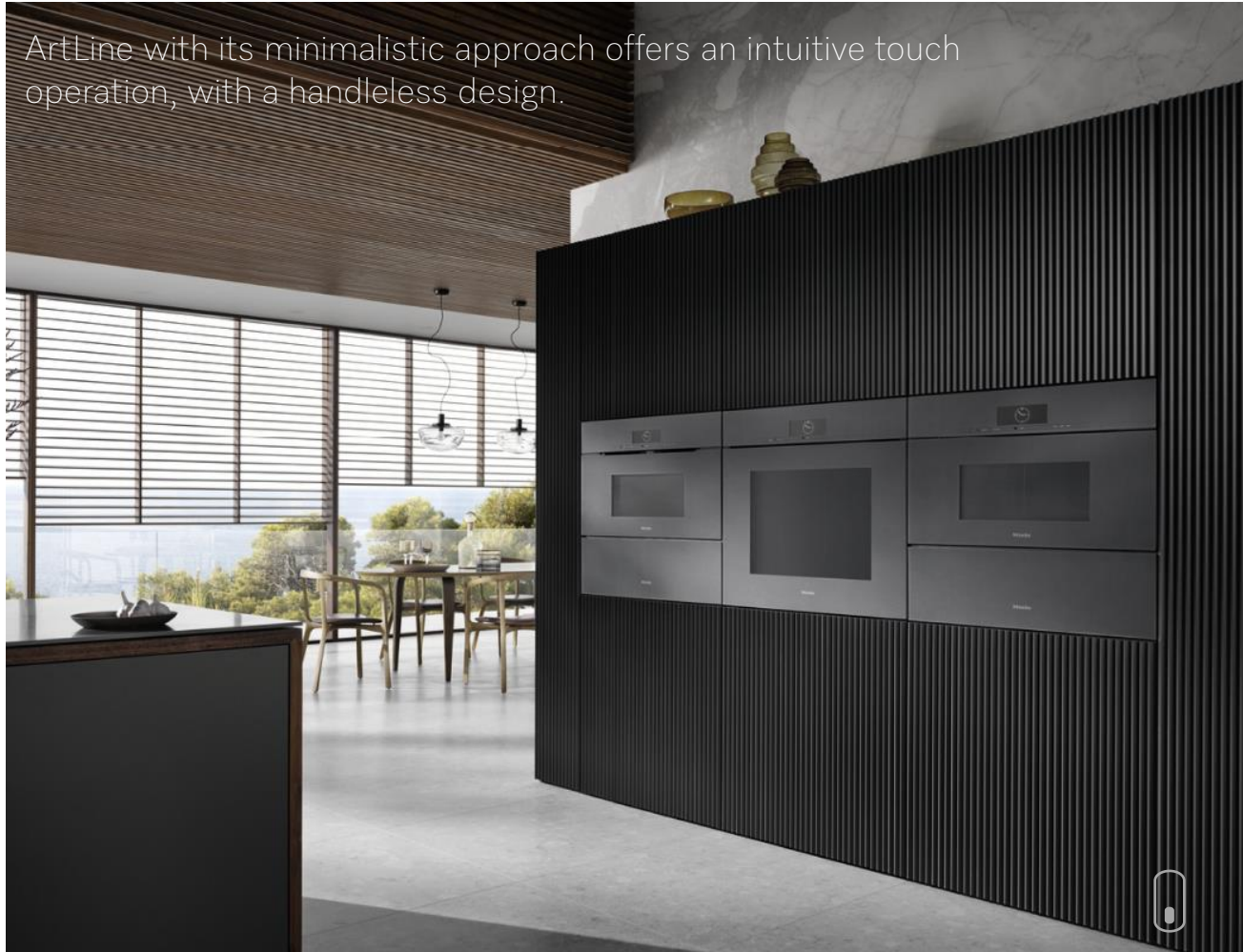

SoftOpen: gently effective

SoftOpen ensures that the door opens gently until it has moved into its final position. The opening mechanism of a kitchen appliance has never been so well executed.



Generation 7000 ArtLine is characterized by handleless glass front panels in graphite grey. Completely flush-mounted with a touch function opens the door gently and effectively. Miele-exclusive technological integrates features like; 'TasteControl', which automatically opens the oven door once cooking is finished to rapidly cool it and 'FoodView', an in-oven camera that can be followed on the Miele app, where users can also remotely adjust multiple functions.

ArtLine Graphite Grey

M Touch



H 7880 BPX GRGR \$11,899.00 
30" Convection Oven



H 7870 BMX GRGR \$6,999.00
30 x 19 Speed Oven
[Integrated Trim Kit]



DGC 7870X GRGR \$ 10,599.00
30 x 19 Combi-Steam Oven
[Integrated Trim Kit]



DGC 7880X XXL GRGR \$11,799.00
30 x 25 Combi-Steam Oven
[Integrated Trim Kit]

Optional: **EBA 7868 GRGR** \$599.00
30 x 24 Trim Kit for Comb-Steam



CVA 7845 GRGR \$8,749.00 
24 x 18 Coffee System

Optional: **EBA 7848 GRGR** \$599.00
30 x 18 Trim Kit for Coffee System

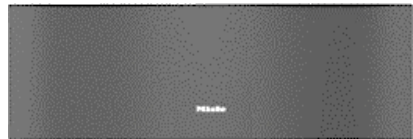

ESW 7680 GRGR \$4,249.00
30 x 11 Warming Drawer

Stacked guideline configuration
[\[Click Here\]](#)

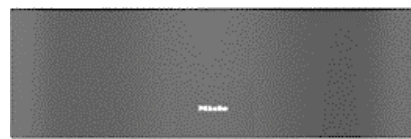

ESW 7670 GRGR \$4,299.00
30 x 10 Warming Drawer

Horizontal guideline configuration
[\[Click Here\]](#)



ESW 7010 GRGR \$2,849.00
24 x 6 Warming Drawer

 Requires a water line

Range Collection



ContourLine 30" Ranges | Induction | Gas | Electric

M Touch

● 12,500 ● 19,500

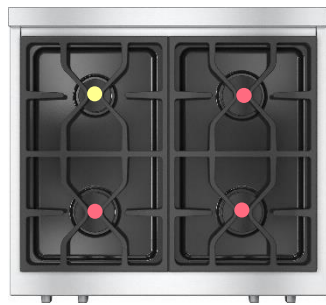

Total BTU Output 71,000



HR 1622-3 I \$13,599.00
 30" Induction w/ M Touch

HR 1924-3 G DF \$13,049.00
 30" 4 Burner w/ M Touch Dual Fuel
 (Available in LP)

EasyControl

● 12,500 ● 19,500



Total BTU Output 71,000

Total BTU Output 71,000



HR 1422-3 I \$11,599.00
 30" Induction EasyControl
 208V or 240V

HR 1421-3 E \$9,599.00
 30" Electric EasyControl
 208V or 240V

HR 1124-3 G AG \$11,899.00
 30" 4 Burner All Gas
 (Available in LP)

HR 1724-3 G DF \$11,899.00
 30" 4 Burner Dual Fuel

ContourLine 36" Range | Dual Fuel | Gas

M Touch

● 12,500 ● 13,600 ● 19,500

EasyControl

● 8,000 ● 9,000 ● 19,500



Total BTU Output 98,200



Total BTU Output 84,100

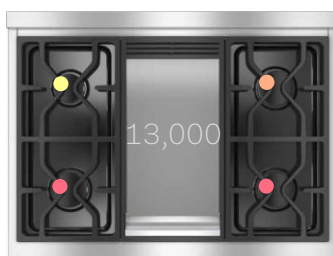

Total BTU Output 78,100



HR 1934-3 G DF \$15,499.00
36" 6 Burner Gas | Dual Fuel
(Available in LP)



HR 1935-3 G DF GR \$16,699.00
36" 4 Burner + Grill | Dual Fuel



HR 1936-3 G DF GD \$16,699.00
36" 4 Burner + Griddle | Dual Fuel
(Available in LP)



Total BTU Output 84,500



Total BTU Output 75,000

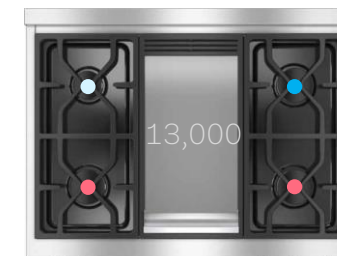

Total BTU Output 69,000



HR 1134-3 G AG \$13,049.00
36" 6 Burner | All Gas
(Available in LP)



HR 1135-3 G AG GR \$14,249.00
36" 4 Burner + Grill | All Gas



HR 1136-3 G AG GD \$14,249.00
36" 4 Burner + Griddle | All Gas
(Available in LP)

Requires a water line

48" ContourLine Range | Culinary Cooking Center

M Touch

● 10,000 ● 13,600 ● 19,500

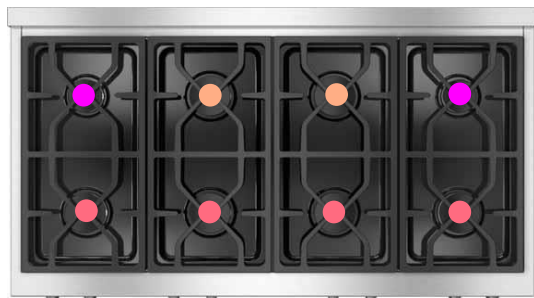

Total BTU Output 125,200



HR 1954-3 G DF \$24,949.00
48" 8 Burner | Dual Fuel [LP option]



Total BTU Output 111,100



HR 1955-3 G DF GR \$26,149.00
48" 6 Burner + Grill | Dual Fuel

Requires a water line



Total BTU Output 105,100



HR 1956-3 G DF GD \$26,149.00
48" 6 Burner + Griddle | Dual Fuel [LP option]

Gas Rangetops



KMR 1124-3 G \$6,049.00
30" 4 Burner | 71,000 BTU's



M Pro Dual Stacked burners have incredibly high BTU output with True Simmer control that offers precision cooking for limitless results.
Direct control - Backlit Precision Knobs
Easy cleaning - dishwasher-safe ComfortClean grates
Convenient and safe - automatic re-ignition for all burners
Cast iron pot rests (matt black enamelled)

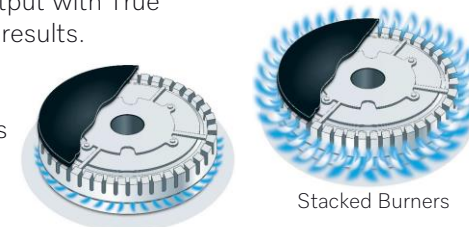

TrueSimmer

Stacked Burners

● 10,000 ● 12,500 ● 13,600 ● 19,500



KMR 1134-3 G \$7,249.00
36" 6 Burner | 98,200 BTU's



KMR 1135-3 G \$8,549.00
36" 4 Burner + Grill | 84,100 BTU's



KMR 1136-3 GD \$8,549.00
36" 4 Burner + Griddle | 78,100 BTU's



KMR 1354-3 G \$8,549.00
48" 8 Burner | 125,200 BTU's



KMR 1355-3 G \$9,699.00
48" 6 Burner + Grill | 111,100 BTU's



KMR 1356-3 G GD \$9,699.00
48" 6 Burner + Griddle | 105,100 BTU's

Range Hoods | Inserts | Blowers



Duct Covers and blowers are sold separately



DAR 1220-3 \$3,499.00
30" Hood w/10" Duct | 700 or 1100 CFM



DAR 1230-3 \$3,749.00
36" Hood w/ 10" Duct | 700 or 1100 CFM



DAR 1250-3 \$3,949.00
48" Hood w/ 10" Duct | 1100 CFM



DAR 1130 \$2,799.00
36" Hood w/ 10" Duct | 700 or 1100 CFM



DAR 1150 \$2,999.00
48" Hood w/10" Duct | 1100 CFM

Blowers are sold separately

Recessed knob controls, Dishwasher-safe stainless steel baffle filters, 4 Fan speeds including Intensive, Hood interior with CleanCover, LED ClearView lighting, Auto-Vent safety sensor

Internal Blowers



DRIB XL \$1,519.00
700 CFM | 10" duct w/ 8" reducing collar [30" or 36" Units]



DRIB XXL \$1,619.00
1100 CFM | 10" Duct [30",36",48", 60"Units]

External Blowers



DREB XL \$1,949.00
700 CFM | 10" duct w/ 8" reducing collar [30" or 36" Units]



DREB XXL \$2,049.00
1100 CFM | 10" Duct [30",36",48", 60" Units]

Blowers are required for Range Hoods | Sold separately from hoods

Range | Range Hood Accessories

BACKGUARD



12" or 20"H
(305 or 508)

30", 36", 48" W x 12" or 20"H

Highly recommended for AG ranges due to the potential of scorching delicate materials when using self-cleaning mode

DUCT COVER



6"H
(152)

30", 36", 48", 60" W
X 6", 12", 18", 24" H

RECIRCULATION KIT

30", 36" Electric or Induction Only



NICHE CLADDING



40"H
(1016)

30", 36", 48" W

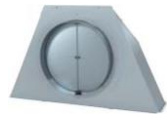

REAR VENTING KIT
DRRV 1200 Series
[Range Hoods]

ACCESSORIES



Wok ring

Cover
RGGC 1000

Telescopic Rack



Cooktops | Electric | Induction | Gas



Induction Cooktops

NEW
Framed [FR]



KM 7720 FR \$3,899.00 | 3 Zones, SmartSelect
24" Induction Cooktop | 208/240V, 40A



KM 7730 FR \$4,499.00 | 4 Zones, SmartSelect
30" Induction Cooktop | 208/240V, 40A



KM 7740 FR \$5,499.00 | 5 Zones, SmartSelect
36" Induction Cooktop | 208/240V, 50A

NEW
Frameless [FL] Launching in 2024

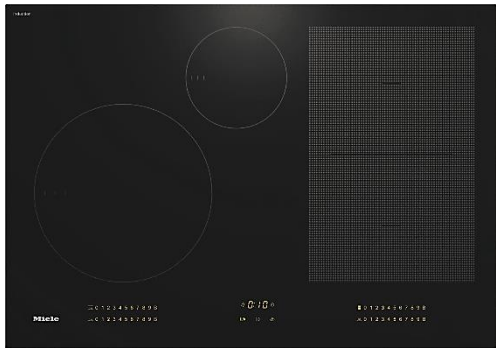

KM 7735 FL \$5,499.00 | 4 Zones, SmartSelect, PowerFlex
30" Induction Cooktop | 208/240V

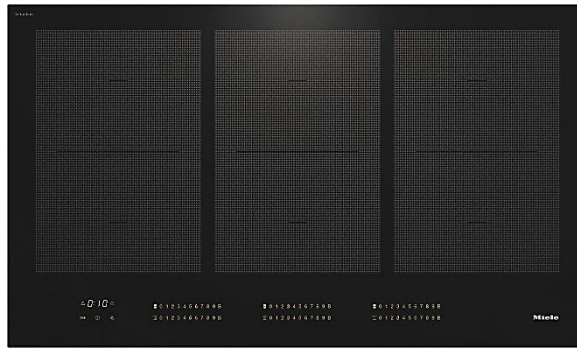

KM 7745 FL \$6,499.00 | 6 Zones, SmartSelect, PowerFlex
36" Induction Cooktop | 208/240V

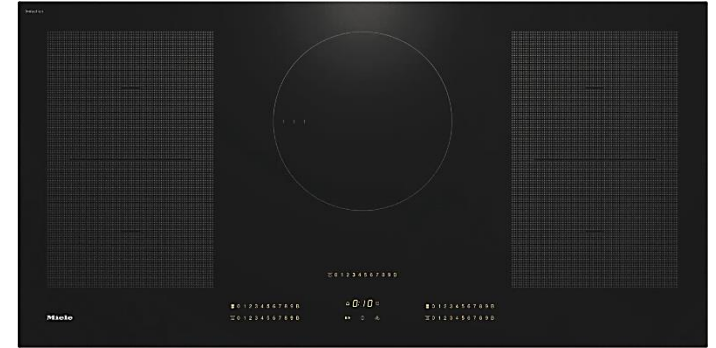

KM 7755 FL \$6,999.00 | 5 Zones, SmartSelect, PowerFlex
42" Induction Cooktop | 208/240V

Gas Cooktops | Classic Design



KM 2012 G \$2,199.00
26" 4 Burner w/ 1 Single Wok

Economy Burner 3,800 BTU
Normal Burner x 2 5,500 BTU
Wok Burner (Front Left) 11,300 BTU
Total Maximum BTU Output 26,100 BTU



KM 2050 G \$3,149.00
36" 5 Burner w/ 1 single Wok

Small Burner 3,500 BTU
Regular Burner 6,200 BTU
Power Burner 8,900 BTU
Wok Burner 12,000 BTU
Total Maximum BTU Output 36,800 BTU



KM 2032 G \$2,899.00
30" 5 Burner w/ 1 single Wok

Economy Burner 3,800 BTU
Normal Burner x 2 5,500 BTU
Power Burner 8,600 BTU
Wok Burner 11,300 BTU
Total Maximum BTU Output 34,700 BTU



KM 2355 G \$3,749.00
36" 5 Burner, 1 dual Wok

Auxiliary Burner 3,900 BTU
Normal Burner 5,900 BTU
High-speed Burner 9,800 BTU
Double-Insert Super Burner 13,000 BTU
Total Maximum BTU Output 38,500 BTU

Flush Fit Installation (optional), Dishwasher safe ComfortClean Grates



KM 2355 G

Features

Stainless steel trough, Premium enamelled cast-iron grates, Cast iron pot rests (matt black enamelled) PerfectClean Burners, Electronic ignition w/ single-hand operation, Safety switch-off, GasStop, GasStop & Restart. All grates are dishwasher safe.

Features vary by model, consult Miele.ca for specific features for each model.



Wok Ring included with cooktops that have wok burner(s)

Gas Cooktops | Linear Design | X Design



KM 3465 G \$3,249.00
30" 4 Burner, 1 dual Wok.

High-Speed Burner (2) 9,000 BTU
Super Burner (1) 12,000 BTU
Wok Burner (Front Left) (1) 15,300 BTU
Total Maximum BTU Output 45,300 BTU



KM 3475 G \$3,849.00
36" 5 Burner w/ 2 dual Woks.

High-Speed Burner (2) 9,000 BTU
Super Burner (1) 12,000 BTU
Wok Burner (2) 15,300 BTU
Total Maximum BTU Output 60,600 BTU



KM 3485 G \$4,049.00
42" 6 Burner w/ 2 dual woks.

Normal Burner (2) 9,000 BTU
Fast Burner (2) 12,000 BTU
Wok Burner (Left) (1) 15,300 BTU
Wok Burner (Right) (1) 16,500 BTU
Total Maximum BTU Output 73,800 BTU



KM 3464 G \$3,249.00
30" 4 Burner w/ 1 dual wok (1 ring incl.)

High-Speed Burner (2) 9,000 BTU
Super Burner (1) 12,000 BTU
Wok Burner (Front Left) (1) 15,300 BTU
Total Maximum BTU Output 45,300 BTU



KM 3474 G \$3,849.00
36" 5 Burner w/ 2 dual woks (1 ring incl.)

High-Speed Burner (2) 9,000 BTU
Super Burner (1) 12,000 BTU
Wok Burner (2) 15,300 BTU
Total Maximum BTU Output 60,600 BTU



KM 3484 G \$4,049.00
42" 6 Burner w/ 2 dual woks (1 ring incl.)

Normal Burner (2) 9,000 BTU
Fast Burner (2) 12,000 BTU
Wok Burner (Left) (1) 15,300 BTU
Wok Burner (Right) (1) 16,500 BTU
Total Maximum BTU Output 73,800 BTU

Stainless steel trough, Premium enamelled cast-iron grates, Cast iron pot rests (matt black enamelled) PerfectClean Burners, Electronic ignition w/ single-hand operation, Safety switch-off, GasStop, GasStop & Restart. All grates are dishwasher safe.

Features vary by model, consult Miele.ca for specific features for each model.



Wok Ring included with cooktops that have wok burner(s)

Electric Cooktops 208V

KnobControls 208V

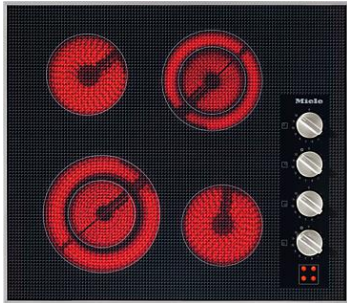

KM 5621 \$1,999.00
24" 4 Zone Cooktop

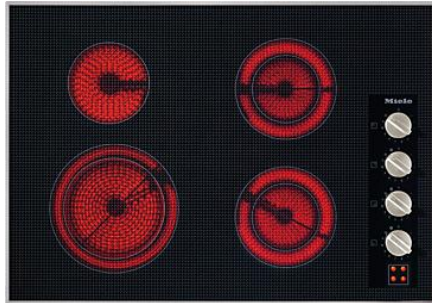

KM 5624 \$2,349.00
30" 4 Zone Cooktop

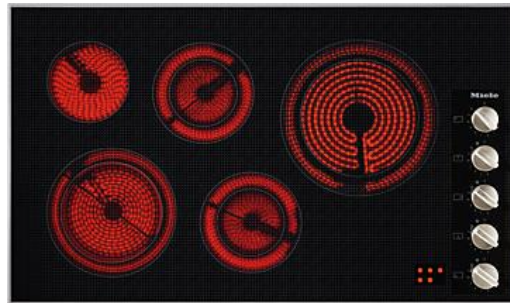

KM 5627 \$2,699.00
36" 5 Zone Cooktop

Features

208V or 240V

Direct Control Plus or Knob Controls, Easy to clean ceramic glass, Stop & Go function, Minute minder, Safety switch-off, Auto heat-up, Lock function, System lock, Fault monitoring, Integrated cooling fan, Overheating protection, Residual heat indicator. **Features vary by model, consult Miele.ca for specific features for each model.**

DirectControls 208V

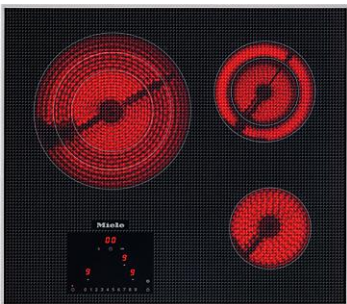

KM 5820 \$2,599.00
24" 3 Zone Cooktop 208 V
(208V Special Order only)
[Click here](#) to see 240V version

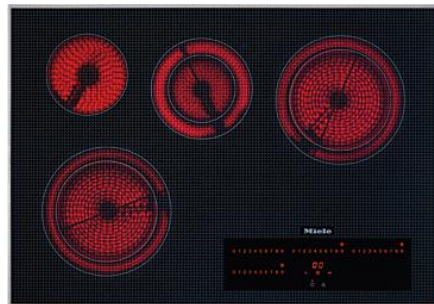

KM 5840 \$2,899.00
30" 4 Zone Cooktop

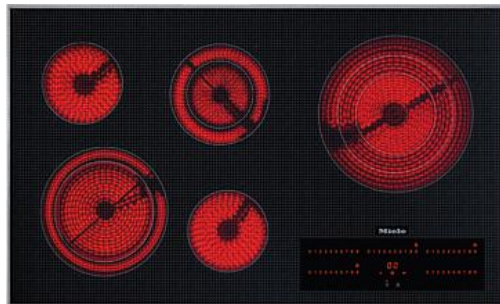

KM 5860 \$3,249.00
36" 5 Zone Cooktop

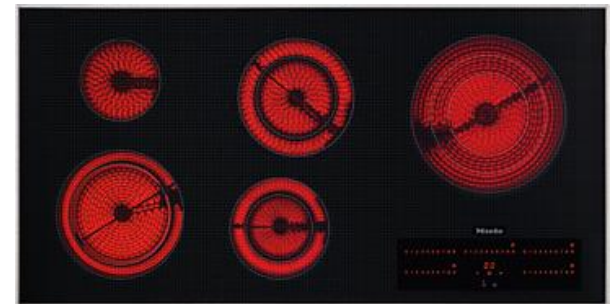

KM 5880 \$3,849.00
42" 5 Zone Cooktop

Electric Cooktops 240V

KnobControls 240V

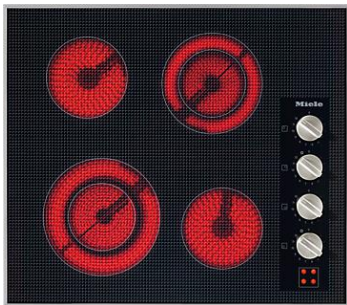

KM 5621 \$1,999.00
24" 4 Zone Cooktop

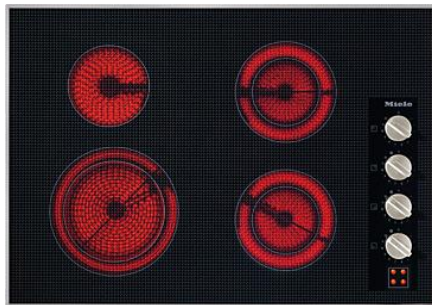

KM 5624 \$2,349.00
30" 4 Zone Cooktop

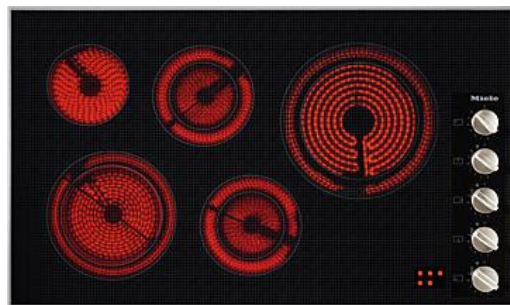

KM 5627 \$2,699.00
36" 5 Zone Cooktop

Features

208V or 240V

Direct Control Plus or Knob Controls, Easy to clean ceramic glass, Stop & Go function, Minute minder, Safety switch-off, Auto heat-up, Lock function, System lock, Fault monitoring, Integrated cooling fan, Overheating protection, Residual heat indicator. **Features vary by model, consult Miele.ca for specific features for each model.**

DirectControls 240V

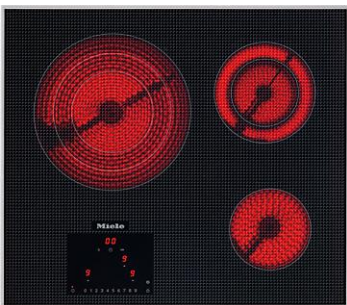

KM 5820 \$2,599.00
24" 3 Zone Cooktop 240 V

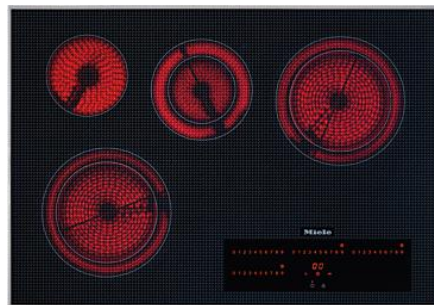

KM 5840 \$2,899.00
30" 4 Zone Cooktop

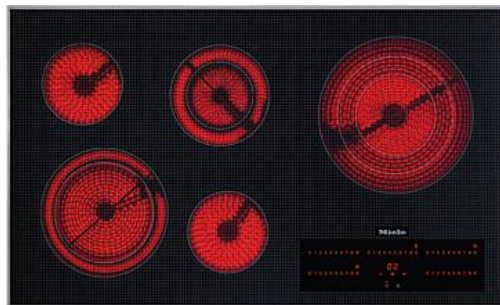

KM 5860 \$3,249.00
36" 5 Zone Cooktop

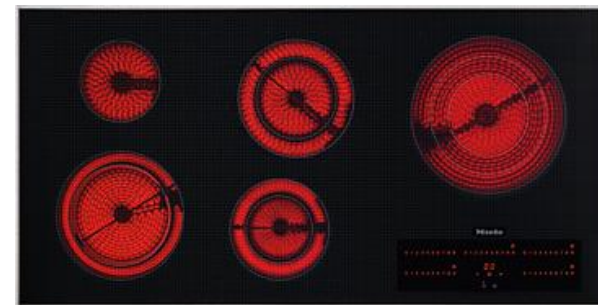

KM 5880 \$3,849.00
42" 5 Zone Cooktop

24" Cooktop + 24" Oven Combo

EasyControl



23 7/16"W (596)

H 2455 B \$4,299.00

EasyControl with PureLine handle, 8 operating modes, Temperature display, Recommended temperature, Halogen Light, Auto heat up, PerfectClean interior, Clean Glass door, 208V/ or 240V



Multi- Residential specific

24" Oven + 24" Cooktop Electric or Induction 208V or 240V. Cooktop plugs into oven EasyControl w/ PureLine handle, 9 oven operating modes, 4 cooktop zones w/ Vario rings, Cooktop controls on oven PerfectClean interior, clean black glass door.

EasyControl | Over Under Combo Units



208V

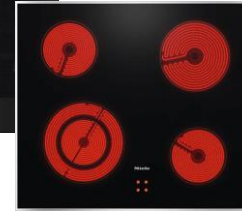

H 2455 E | KM 6050 | 208V \$4,749.00
24" PureLine EasyControl Oven + Electric Cooktop



240V



H 2455 E | KM 6050 | 240V \$4,749.00
24" PureLine EasyControl Oven + Electric Cooktop



208V



H 2455 I | KM 7020 | 208V \$5,949.00
24" PureLine EasyControl Oven + Induction Cooktop



240V



H 2455 E | KM 7020 | 240V \$5,949.00
24" PureLine EasyControl Oven + Induction Cooktop

Insert Hoods



DA 2360 \$1,649.00
24" Insert Hood Fan
6" Duct | 483 CFM

New Size



DA 2390 \$2,749.00
35" Insert Hood Fan
6" Duct | 500 CFM



DA 2588 \$2,349.00
32" Insert Hood Fan
6" Duct | 500 CFM



DA 2518 \$3,149.00
44" Insert Hood Fan
6" Duct | 500 CFM



Electronic controls, LED lighting, Con@ctivity, Miele@home, WiFi@Conn@ct, Acoustic Package, Run-on time 5/15 min., 10 ply stainless steel grease filter, Grease filter indicator, 3 Power levels + 1 Booster level, Clean Cover (canopy interior), Dishwasher safe filters, Dual action fan, Automatic switch-off feature (after 10 hours)

Features vary by model, consult Miele.ca for specific features for each model.

Slimline Retractable Visor Hood Fan



DAS 2620 \$2,049.00
24" Slimline Retractable Visor Hood Fan
6" Duct | 327 CFM



DAS 4720 \$2,149.00
30" Slimline Retractable Visor Hood Fan
6" Duct | 498 CFM



DAS 4920 \$2,249.00
36" Slimline Retractable Visor Hood Fan
6" Duct | 498 CFM



DAS 4940 \$2,699.00
36" Slimline Retractable Glass Visor
Hood Fan 6" Duct | 501 CFM

Tilt-Out Hood (Slot-in) | Built-under Hoods



Invisible Design concealed with a cabinet door (panel ready) Electronic controls, LED lighting, 10 ply stainless steel grease filter 3 Power levels + 1 Booster level 2 dishwasher safe filters, Clean Cover (canopy interior) Dual action fan
Available option to recirculate.



DA 186 \$1,599.00
24" Tilt-out Hood Fan
6" Duct | 330 CFM



DA 188 \$1,699.00
30" Tilt-out Hood Fan
6" Duct | 330 CFM



DA 189 \$1,799.00
36" Tilt-out Hood Fan
6" Duct | 330 CFM



Mechanical controls, LED lighting, 10 ply stainless steel grease filter, 3 Power levels+ 1 Booster level, Clean Cover (canopy interior), Dishwasher safe filters, Single action fan



DA 1260 \$1,299.00
24" Built-under Hood Fan
6" Duct | 320 CFM



DA 1280 \$1,399.00
30" Built-under Hood Fan
6" Duct | 320 CFM

Downdraft Systems



Electronic controls, LED lighting, 10 ply stainless steel grease filters, Dishwasher safe filters, 3 Power levels + 1 Booster level, Dual action fan, Run-on time 15 min, Automatic switch-off feature (after 10 hours) Single pane tempered glass (Recommended for Island applications due to do required depth)



DAG 600 \$539.00
Internal Blower



DAG 1000 \$1,619.00
External Blower



DA 6881 D \$3,599.00
30" Downdraft Fan & Blower
6" Duct | 425 CFM
[Blower sold separately]



DA 6891 D \$3,649.00
36" Downdraft Fan & Blower
6" Duct | 425 CFM
[Blower sold separately]

Hood Fans | Wall Mount

Features

NEXT STEP | PURISTIC CANTO | PURISTIC EDITION 6000

Electronic controls, LED lighting, Con@ctivity, Miele@home, WiFi@Conn@ct, Eco Motor, Acoustic Package, Run-on time 5/15 min., 10 ply stainless steel grease filter, Grease filter indicator, 3 Power levels + 1 Booster level, Clean Cover (canopy interior), Dishwasher safe filters, Single pane tempered glass, Dual action fan, Telescopic chimney, Automatic switch-off feature (after 10 hours) Optional recirculating with charcoal filter (grill stack exposed) Hood Extensions for higher ceilings - DA models only [6" Duct | 489 CFM]

Features vary by model, consult Miele.ca for specific features for each model.



30"(760)
OR
39 3/8"(1000)

DATK1-760 \$329.00

DATK2-1000 \$379.00
(For DA hoods only)



Vented
26 (660)
-
38 5/8" (980)

DA 5798 W \$3,849.00
36" Chimney Hood



Vented
27 3/8" (693)
-
39 7/8" (1,010)

DA 6596 W \$4,899.00
36" Chimney Hood
OPT. Edge extraction panels
stainless Steel or Glass



Vented
28" (710)
-
40 5/8" (1,030)

DA 6698 W \$6,049.00
36" Chimney Hood



Vented
27 (685)
-
39 5/8" (1005)

PUR 68 W \$2,149.00
24" Chimney Hood



PUR 88 W \$2,299.00
30" Chimney Hood



PUR 98 W \$2,499.00
36" Chimney Hood

Features

PUR HOOD & TRAPIZIOD HOOD

Electronic controls, LED lighting, 10 ply stainless steel grease filter, 3 Power levels + 1 Booster level, Clean Cover (canopy interior), dishwasher safe filters, Dual action fan, Telescopic chimney, Automatic switch-off feature (after 10 hours)



Vented
27 3/8" (693)
-
40" (1,015)

DA 398-7 W \$2,899.00
30" Chimney Hood



Vented
27 3/8" (693)
-
40" (1,015)

DA 399-7 W \$3,049.00
36" Chimney Hood

Hood Fans | Island Mount



Vented
38 1/4" (970)
50" (1,270)

PUR 98 D \$4,899.00
36" Chimney Hood

[Excluded from all @ features]

Features

Electronic controls, LED lighting, Con@ctivity, Miele@home, WiFi@Conn@ct, Acoustic Package, Run-on time 5/15 min., 10 ply stainless steel grease filter, Grease filter indicator, Eco Motor, 3 Power levels + 1 Booster level, Clean Cover (canopy interior), Dishwasher safe filters, Single pane tempered glass, Dual action fan, Telescopic chimney, Automatic switch-off feature (after 10 hours)
Features vary by model, consult Miele.ca for specific features for each model.

[6" Duct | 507 CFM]

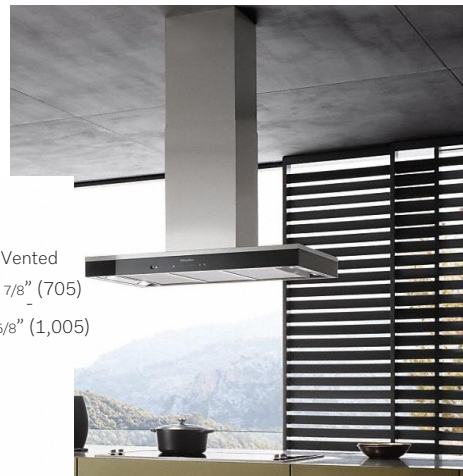

Vented
27 7/8" (705)
39 5/8" (1,005)

PURISTIC EDITION 6000
Touch on glass controls



47 1/4" (1200)

PURISTIC VARIA | DA 4248 V D
W/ Motorized height adjustment of 12"

Vented
29 3/4" (755)
41 1/4" (1,045)



DA 4248 V D \$7,849.00
42" Motorized Chimney Hood

6" Duct | 489 CFM



Vented
27 1/4" (690)
39" (990)

PURISTIC CANTO
OPT. Edge extraction panels
stainless Steel or Glass

DA 6596 D \$6,449.00
36" Chimney Hood



DA 6698 D \$7,249.00
36" Chimney Hood



Pre-finished

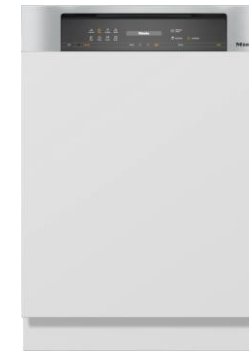

Integrated



Fully Integrated

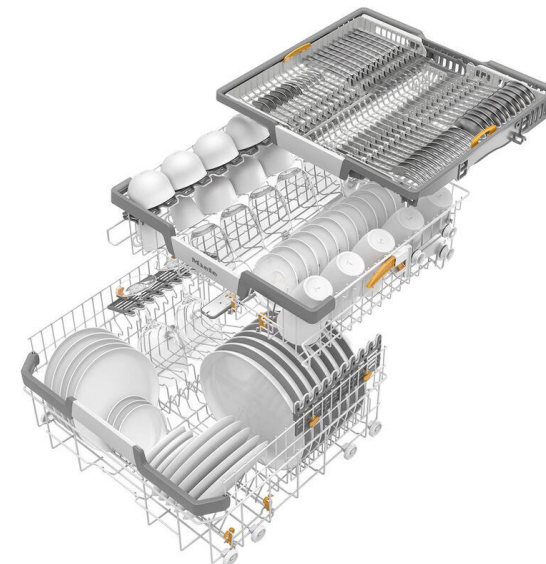

Cutlery Basket



Multi-Flex Sliding Cutlery Tray

Dishwashers



WiFiConn@ct + Miele App

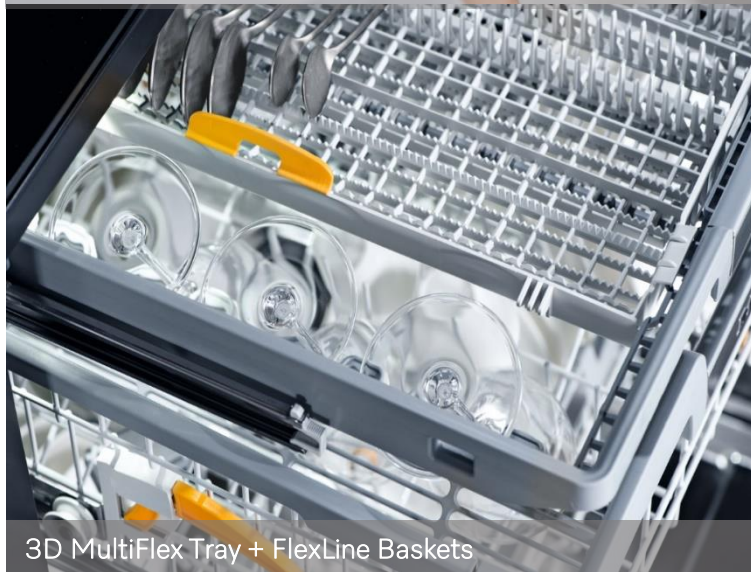

3D MultiFlex Tray + FlexLine Baskets



Knock2Open



"A world first: AutoDos with integrated Power Disk"



QuickIntenseWash 58 minute cycle

Dishwashers | 5000 Series



G 5006 U CLST \$1,949.00



G 5006 U BRW \$1,799.00



G 5006 SCU CLST \$2,149.00



G 5006 SCU BRW \$1,999.00



G 5006 SCU OBS \$1,999.00



G 5051 SCVi \$2,549.00 (ADA)



G 5056 SCVi \$2,349.00



G 5056 SCVi

- U = Basket | Prefinished
- SCU = Cutlery Tray | Prefinished
- SCVi = Cutlery Tray | Hidden Controls (panel ready)



G 5216 SCU CLST \$2,449.00



G 5266 SCVi \$2,649.00



G 5482 SCVi \$2,749.00 (18" Slimline)

GFVi 453/72-7 \$404.00
 18" SlimLine CleanTouch Steel Door Panel (optional)

Dishwashers | 7000 Series



Pre-finished, 3D MultiFlex Tray, AutoOpen Drying, CleanTouch Steel
G 7106 SCU SS \$2,899.00



Fully Integrated, Full-size, 3D MultiFlex Tray, AutoOpen Drying
G 7156 SCVi \$3,099.00



Integrated, Automatic dispensing – AutoDos w/ integrated PowerDisk®, 3D MultiFlex Tray, BrilliantLight, MaxiComfort Basket
G 7516 SCi \$3,999.00



Fully Integrated, Automatic dispensing – AutoDos w/ integrated PowerDisk®, 3D MultiFlex Tray, BrilliantLight, MaxiComfort Basket
G 7566 SCVi \$4,099.00



Pre-finished, Automatic dispensing – AutoDos with integrated PowerDisk®, 3D MultiFlex Tray, CleanTouch Steel
G 7316 SCU \$3,299.00



Fully Integrated, Automatic dispensing – AutoDos with integrated PowerDisk®, 3D MultiFlex Tray
G 7366 SCVi \$3,499.00



Integrated, Automatic dispensing – AutoDos w/ integrated PowerDisk®, 3D MultiFlex Tray, BrilliantLight, M Touch display
G 7916 SCi \$4,899.00



Fully Integrated, Automatic dispensing – AutoDos w/ integrated PowerDisk®, 3D MultiFlex Tray, BrilliantLight, M Touch display
G 7966 SCVi K20 Knock 2 Open \$4,999.00

ProfiLine Dishwashers

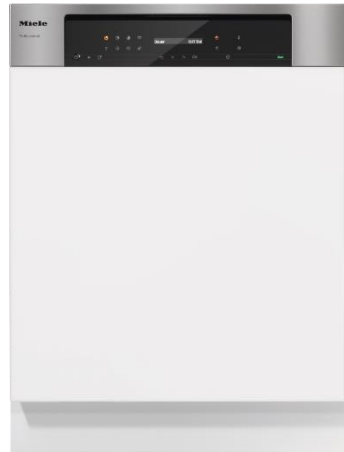

PFD 102 i (ADA) \$5,763.00

13 place settings, ADA Compliant
 52 min 120 V | 24 min 208 / 240 V
 Certified EMC, CE, VDE, EN 717,
 Max final rinse Temp 180°F | 82°C ,
 WaterControl system, 8 Programs,
 AutoOpen drying, BrilliantLight, safety lock,
 Select model based on voltage requirements

Ideal for office kitchens,
 staff rooms and utility rooms.

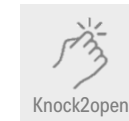

PFD 104 SCVi K20 \$6,970.00

Knock 2 Open
 16 place settings in 24 min at 208 / 240 V
 Certified EMC, CE, VDE, EN 1717, UL
 Max final rinse Temp 180°F | 82°C ,
 WaterControl system, 8 Programs,
 AutoOpen drying, BrilliantLight, safety lock,

Ideal for households, office kitchens,
 staff rooms and utility areas.

MasterCool



MasterCool



MasterCool



MasterCool



SoftClose
Solid doors are closed gently and prevent objects from rattling and slipping inside the door.

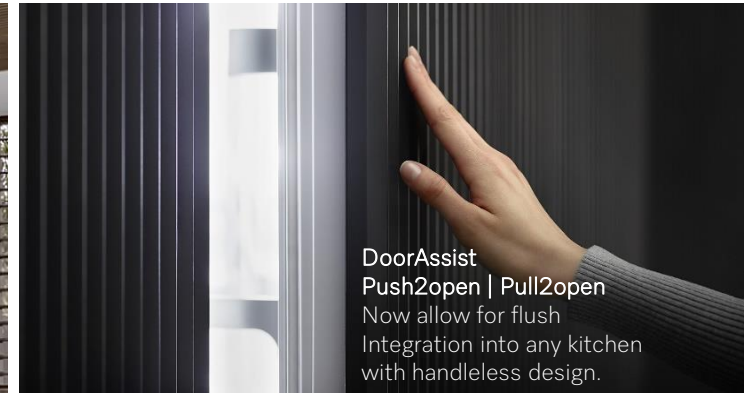

DoorAssist
Push2open | Pull2open
Now allow for flush integration into any kitchen with handleless design.



WifiConn@ct
Convenient and time saving, use your WiFi to remotely operate and monitor your appliance.



MasterCool Single Door Freezers

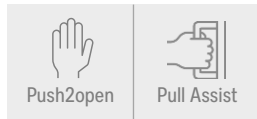

F 2412 Vi
\$11,099.00

18" Single Door Freezer
Freezer Capacity 8.6 cu. ft. / 242L



F 2472 Vi
\$12,299.00

18" Single Door Freezer
Freezer Capacity 7.8 cu. ft. / 219L
Ice + Water
Dispenser



F 2672 Vi
\$13,549.00

24" Single Door Freezer
Freezer Capacity 11.2 cu. ft. / 318L
Ice + Water
Dispenser



F 2812 Vi **F 2802 Vi**
\$13,549.00 \$13,549.00

30" Single Door Freezer
Freezer Capacity 15.8 cu. ft. / 446L



F 2912 Vi
\$14,799.00

36" Single Door Freezer
Freezer Capacity 19.4 cu. ft. / 549L



F 2902 Vi
\$14,799.00

Panel Ready -Optional CleanTouch Stainless Steel panels and handles are sold separately

Vi – Integrated Flush mount | F=Freezer, 24XX=18", 26XX=24", 28XX=30", 29XX=36", XX(1)X=L hinge, XX(0)X=R hinge | Requires a water line

Merging Kit
KSK2002
\$1,199.00
Required between all towers when installed side by side
[Click here for further details](#)

MasterCool Single Door Fridges | Vi



Spec Sheets



Push2open



Pull Assist



K 2612 Vi
\$11,649.00



K 2602 Vi
\$11,649.00



K 2812 Vi
\$12,899.00



K 2802 Vi
\$12,899.00



K 2912 Vi
\$14,099.00



K 2902 Vi
\$14,099.00

24" Single Door Refrigeration
Refrigerator capacity 13 cu. ft. / 367 L

30" Single Door Refrigeration
Refrigerator capacity 16.8 cu. ft. / 475 L

36" Single Door Refrigeration
Refrigerator capacity 20.6 cu. ft. / 582 L

Merging Kit
KSK2002
\$1,199.00
Required between all towers when installed side by side
[Click here for further details](#)

Panel Ready -Optional CleanTouch Stainless Steel panels and handles are sold separately

Vi – Integrated Flush mount | K= Fridge, 26XX=24", 28XX=30", 29XX=36", XX(1)X=L hinge , XX(0)X=R hinge | Requires a water line

MasterCool Bottom Mount Fridge | French Door Fridge | Vi



Spec Sheets



Push2open



Pull Assist

On refrigeration doors only



KF 2812 Vi LH
\$15,099.00

30" Bottom Mount Refrigeration
Refrigerator capacity 11.4 cu. ft. / 323 L
Freezer Capacity 4.6 cu. ft. / 129L



KF 2802 Vi RH
\$15,099.00



KF 2912 Vi LH
\$16,449.00

36" Bottom Mount Refrigeration
Refrigerator capacity 14 cu. ft. / 397 L
Freezer Capacity 5.6 cu. ft. / 157L



KF 2902 Vi RH
\$16,449.00



KF 2982 Vi
\$16,999.00

36" French Door Refrigeration
Refrigerator capacity 13.8 cu. ft. / 393 L
Freezer Capacity 5.6 cu. ft. / 157L

Merging Kit
KSK2002
\$1,199.00
Required between all towers when installed side by side
[Click here for further details](#)

Panel Ready -Optional CleanTouch Stainless Steel panels and handles are sold separately

Vi – Integrated Flush mount |KF=Bottom Mount, 28XX=30", 29XX=36", XX(1)X=L hinge, XX(0)X=R hinge | Requires a water line

MasterCool | Bottom Mount Fridge | French Door Fridge | SF



'SF' Series includes CleanTouch Stainless panels, Proud frame with Gen 7000 ContourLine handles

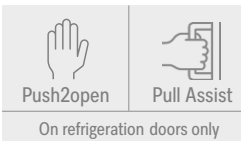
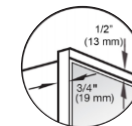

KF 2812 SF 💧
\$17,699.00

30" Bottom Mount Refrigeration
Refrigerator capacity 11.4 cu. ft. / 323 L
Freezer Capacity 4.6 cu. ft. / 129L



KF 2802 SF 💧
\$17,699.00



KF 2912 SF 💧
\$18,899.00

36" Bottom Mount Refrigeration
Refrigerator capacity 14 cu. ft. / 397 L
Freezer Capacity 5.6 cu. ft. / 157L



KF 2902 SF 💧
\$18,899.00



KF 2982 SF 💧
\$19,599.00

36" French Door Refrigeration
Refrigerator capacity 13.8 cu. ft. / 393 L
Freezer Capacity 5.6 cu. ft. / 157L

Merging Kit KSK2002
\$1,199.00
Required between all towers when installed side by side
[Click here for further details](#)

SF – Integrated Proud mount w/ CleanTouch Stainless Steel Panels, frame and ContourLine handle.
Vi – Integrated Flush mount |KF=Bottom Mount, 28XX=30", 29XX=36", XX(1)X=L hinge , XX(0)X=R hinge | Requires a water line 💧

MasterCool Wine Towers



Spec Sheets



Push2open



Pull Assist



KWT 2612 Vi
\$13,799.00



KWT 2602 Vi
\$13,799.00

24" Wine Tower 3 Zone
Refrigerator capacity 13.4 cu. ft. / 379 L
Bottle Capacity 104



KWT 2672 ViS
\$14,399.00



KWT 2662 ViS
\$14,399.00

24" Wine Tower 3 Zone w/ SommelierSet
Refrigerator capacity 13.4 cu. ft. / 379 L
Bottle Capacity 77



MasterCool –
SommelierSet

Simply perfect for wine connoisseurs – with the unique SommelierSet exclusively from Miele. Prepare fine wines professionally for decanting. Enjoy champagne and white wine from chilled glasses. Drink perfectly conditioned wine even from opened bottles.



MasterCool – FlexiFrame

Holds bottles of all sizes securely. The adjustable wooden bottle racks hold every size of bottle securely. The individual slats can be moved easily to suit every bottle shape. This provides the perfect storage position for your wine.



MasterCool – Push2open

The perfect solution for a handle-free design with the Push2open function open automatically. The opening mechanism can be actuated merely by gently pressing the door. The door then opens gently and allows you to reach inside and open it completely.

Please note: SommelierSet cannot be added or converted within KWT 2612 Vi and KWT 2602 Vi models

Panel Ready -Optional CleanTouch Stainless Steel panels and handles are sold separately

Vi – Integrated Flush mount | KWT= Wine Storage System, 26XX=24 | Requires a water line 💧

Merging Kit
KSK2002
\$1,199.00
Required between all towers when installed side by side
[Click here for further details](#)

European Refrigeration



European Refrigeration



European Built-In All Freezer | All Fridge

NEW



FreshTouch controls adjusts all functions and features with a quick touch of the interface display.



Optimum and maintenance-free LED lighting in compartment



Soft closing of the door with SoftClose hinge.



Perfect Ice Cubes
Thanks to the IceMaker with freshwater connection

Double the convenience with Miele's Ice&PizzaBox NoFrost and 8 freezer drawers on telescopic runners for maximum convenience.

No icing up of food and no need to defrost thanks to NoFrost.

Connected Home with Miele@home. Cleverly networked. Make your life smart: thanks to Miele@home, you can cleverly network your domestic appliances – for more options.



FNS 7794 E
\$4,999.00

24" Single Door Freezer

Freezer Capacity 7.77 cu. ft. / 220 L



KS 7793 D
\$4,999.00

24" Single Door Fridge

Refrigerator capacity 10.88 cu. ft. / 308 L

Requires door panel and handle | Convertible hinges | Requires a water line



PerfectFresh
Active freshness system with active humidification in top drawer

Food stays fresh for up to 5 times longer due to active humidification and sealing lid. Water turns into mist with ultrasonic technology every 90 minutes and every door opening. Water tank (100ml) integrated in the division plate above the drawer. Fully telescopic runners



Uniform temperature distribution with DynaCool.



Easy to remove items thanks to pivotable glass shelf – FlexiTray



Extensive depth makes it possible to place a whole baking tray on the bottom drawer level

European Built-In Bottom Mount & French Door Refrigeration

NEW



KFN 7734 D
\$4,349.00

24" Bottom Mount Fridge
Refrigerator capacity 6.85 cu. ft. / 194 L
Freezer Capacity 2.19 cu. ft. / 62L



KFN 7784 D
\$5,749.00

24" Bottom Mount Fridge
Refrigerator capacity 6.99 cu. ft. / 198 L
Freezer Capacity 2.22 cu. ft. / 63L



KFN 9859 iDE RH 💧
\$10,499.00

30" Bottom Mount Fridge
Refrigerator capacity 9.8cu. ft. / 278L
Freezer Capacity 4.3cu. ft. / 122L



KFN 9859 iDE LH 💧
\$10,499.00

Also available in
Left Hinged



KFNF 9959 iDE 💧
\$12,499.00

36" French Door Fridge
Refrigerator capacity 10.45cu. ft. / 296L
Freezer Capacity 6 cu. ft. / 170L

Requires door panels and handles | Requires a water line 💧

All pricing, codes, specs, images, features and dimensions are subject to change without notice. Always refer to Miele.ca for current information [2024]

European Bottom Mount | Freestanding Refrigeration

NEW



KFN 4799 DDE NA
 \$5,999.00

24" Freestanding Bottom Mount Fridge



KFN 4776 ED

30" Freestanding Bottom Mount Fridge

Launching Q3 2024



KFN 15943 D edt/cs
 \$6,049.00

30" Freestanding Bottom Mount Fridge

Refrigerator capacity 11.7 cu. ft. / 331 L

Freezer Capacity 4.3 cu. ft. / 121L



KFN 15943 DE edt/cs
 \$6,999.00

30" Freestanding Bottom Mount Fridge

Refrigerator capacity 11.7 cu. ft. / 331 L

Freezer Capacity 4.3 cu. ft. / 121L

Requires a water line

European Built-Under Refrigeration



K 3122 Ui \$2,999.00

24" Undercounter All Fridge

Refrigerator capacity 4.8 cu. ft. / 136 L

Built-under Integrated Refrigeration

Door hinge | RIGHT (convertible to left)
Panel ready, LED lighting, PicTronic Controls,
ComfortClean, 1 Vegetable drawer, Acoustic door alarm

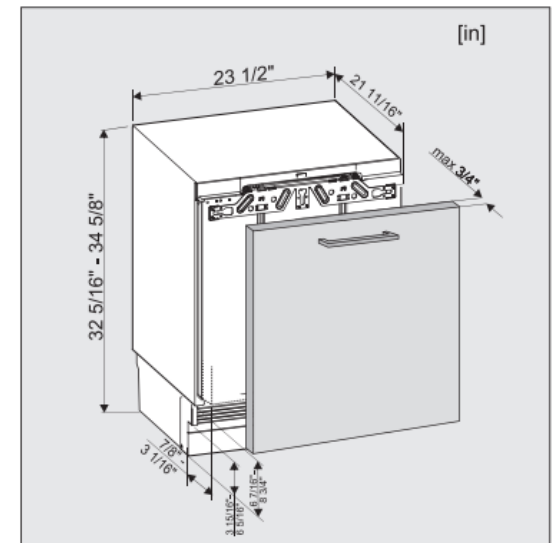

Niche Openings:
Width 23 5/8" (600)
Height 32 3/8" (820) – 43 3/4" (880)
Depth 21 3/4" (550)

European Built-Under Wine Storage Systems



KWT 6312 UGS \$6,299.00

24" Under Counter Wine Sommelier
Bottle Capacity 46 bottles (w/o Sommelier Set)

- Sommelier Set (optional use)
- Temperature zones | 1
- Wooden racks | 4
- FlexiFrame wooden racks | 3



32 1/4" H (818)

KWT 6322 UG \$6,049.00

24" Under Counter Wine
Bottle Capacity up to 34 bottles

- Temperature zones | 2
- Wooden racks | 4
- FlexiFrame wooden racks | 3



Merging kit KSK6300 is required for side-by-side combination

Built-in under-counter Integrated appliance: Door hinge | RIGHT (convertible to left) Glass door w/ UV filters, Side by Side enabled, LED lighting, DynaCool, Soft close, Push2Open, TouchControl, Active Air Clean Filter, Lock function, Acoustic door alarm, Acoustic temperature alarm
Niche Openings: Width 23 5/8" (600) Height 32 5/16"(820) Depth 24" (610)

KWT= Wine Storage System, UG = Under counter Integrated

Domestic & Professional Laundry



The new Little Giants from Miele.

Discover the compact washing machines and tumble dryers for commercial use – and discover innovative technologies for even greater cleaning performance, economy, user convenience and flexibility.



The Little Giants Laundry System



PDR 908 HP [EL] \$5,430.00
24" Professional Heat-Pump Dryer
Lotus White

PWM 908 [EL DP] \$7,335.00
24" Professional Washing Machine
Lotus White

PDR 908 HP [EL] \$5,710.00
24" Professional Heat Pump Dryer
Stainless Steel

PWM 908 [EL DP] \$7,605.00
24" Professional Washing Machine
Stainless Steel

23 7/16 W x 33 7/16 H x 28 1/4 D.
(596 x 850 x 777)



Little Giants Features

- M Touch Flex
- 32 Languages
- 96-hour delay start
- Miele App Wi-Fi Connect
- Stackable or Side-by-side
- Tested for 30,000 operating hours
- Residential & Commercial Use
- Operates 8 hours a day / 365 days a year
- 208 / 240 v 30 amps
- Plug type Nema L6-30



Little Giants Dryer

- 4.6 cu. ft.
- Heat Pump technology – Ventless
- 35 Programs 3 Hygienic Programs
- Energy Star rated
- FragranceDos for fresh scented fabrics
- Temperature (F) range 140° - 185°
- 185° / 15-minute hold time
- Heat pump 2x larger than domestic models
- Independent fan drive for faster drying results
- Professional Brush-less Permanent Magnet Motor



Little Giants Washer

- 2.6 cu. ft. / 20 lb. capacity
- CapDos Specialized dispense capsules
- 50+ Wash Programs 14 Hygienic Programs
- 25 min Express wash program
- 49 min. Intensive Wash
- 3 Commercial Shock Absorbers – for smooth running at high speeds
- 3D Sensor: Monitors load imbalances, detects rotational speed
- Perforated rear panel for faster drenching and draining
- Powerful heater elements for heating water quickly



APCL 001 \$225.00
Stacking kit
1 3/16" (30) H



TRK555 \$119.00
Dryer Basket



Domestic Washers | Heat Pump Dryers



W1 Classic
120V / 60 Hz EnergyStar
CapDosing, 1600 RPM
Hot / Cold Connection
WIFI, Delay Start
Normal, Delicates,
Sanitize, Handwash,
Dress Shirts,
Darks/Denims, Express,
Extra White, Outdoor,
Proofing, Drain/Spin,
SoftSteam.

WXD160 WCS \$2,499.00
24" Front Loading Washer



+ Drum lighting
+ Eco feedback
+TwinDos
+ Chrome ring door
22 Programs

WXF660 WCS TDos \$3,099.00
24" Front Loading Washer



+ IntenseWash System
+ SingleWash
+ QuickIntenseWash 49
23 Programs

WXI860 WCS TwinDos&IntenseWash \$3,799.00
24" Front Loading Washer



+ M Touch
27 Programs

33 1/2" - 34 3/4" H
(850 - 882)

WXR860 WCS TwinDos&IntenseWash \$4,399.00
24" Front Loading Washer



T1 Classic
120V / 60 Hz Heat
Pump, Energy Star,
FragranceDos, WIFI,
AddLoad, Delay Start,
Normal, Delicates,
Bed Linens,
Woolens/Silks, Dress
shirts, Denims,
Smoothing, Express,
Outdoor, Proofing,
Time Dry / Dry Fresh.

TXD160 WP \$2,499.00
24" Heat Pump Dryer



+Eco Feedback
+ SoftSteam
+Chrome Ring Door
19 Programs

TXI680 WP FragranceDos2Eco&Steam \$3,299.00
24" Heat Pump Dryer



+M Touch
20 Programs

33 1/2" - 34 3/4" H
(850 - 882)

TXR860 WP Eco&Steam \$4,099.00
24" Heat Pump Dryer



FragranceDos \$23.99 Aqua,
Cocoon, Nature 50 Dryer Cycles



Dryer Basket Included
w/ TRX860



WTV 502 \$119.00
1"H (25.4)

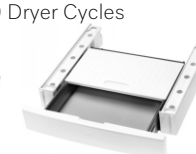

WTV 512 \$409.00
4 3/4"H (121)



WTS 510 \$719.00
13 3/4" H(350)

Domestic Heat Pump Dryer Technology



Heat Pump Dryer

Closed air circuit - Processed air is dehumidified inside the unit (using refrigerant) Air is heated using refrigerant only giving off 6% moisture **No Venting** required for ease of installation, low maintenance and high efficiency. **60% More efficient than a vented dryer.**

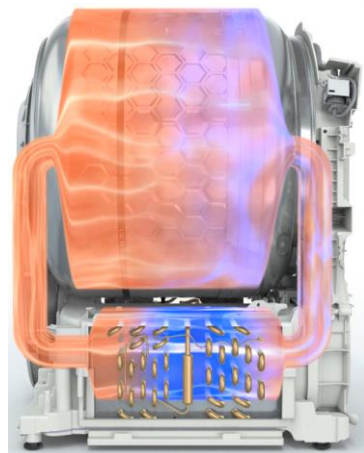

Principle of Operation

- Hot dry air is pumped into drum which absorbs moisture from the laundry.
- The Moisture-laden air passes through filters on the way to the evaporator where the air is cooled in the Coolant Circuit.
- The cooled air passes through a condenser which captures the moisture.
- The reprocessed air (now dry again) is then pumped back into drum.
- This cycle repeats until the load is dry.

Due to the efficiency of Heat Pump technology a 208V/240V NEMA 14-30 plug is no longer required for the dryer. Use a standard household 120V/15A. Miele supplies a Nema Adapter w/ every dryer.



Products that make the ENERGY STAR Most Efficient list for 2023 deliver cutting edge energy efficiency along with the latest in technological innovation. They represent the year's very best for energy savings and environmental protection.

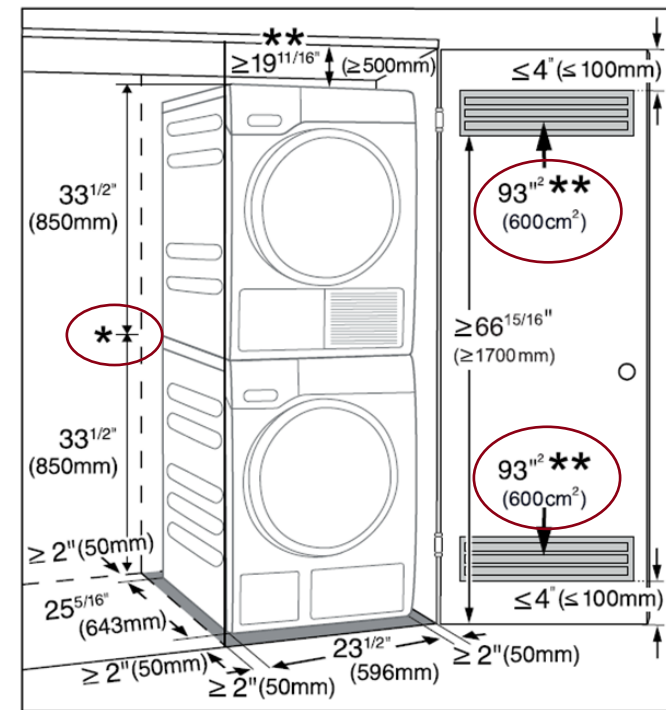

*Height w/ stacking kit
WTV502 = 67 3/8" (1711) | WTV502 = 71 1/8" (1806)

** If it is not possible to fulfill the air flow specifications you may have longer drying time.

Domestic Washer Technology



The primary pump fills the drum with detergent and water, settling at the bottom. The secondary pump redistributes the sudsy water to the top of the drum allowing for even distribution and a thorough cleaning.

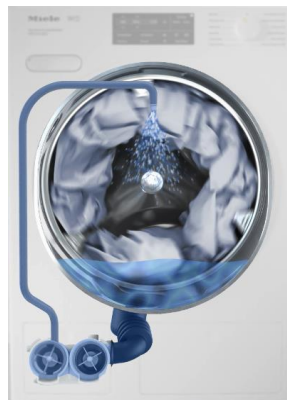

CapDosing | Specialty Detergent Enhancers
Automatically dispenses at the right time in the wash process. Pods are made for specific program / clothing. Wool, Sport, Silk, Outdoor gear, Booster, Fabric Softener.

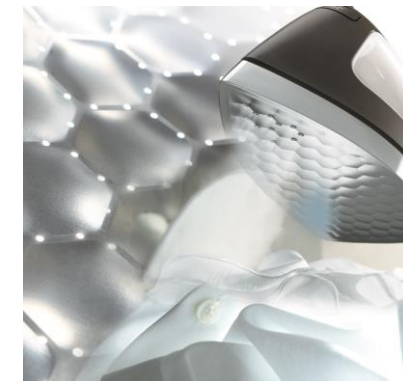

Honeycomb Drum
Soft to the touch: the hexagonal sculptured surface of the drum allows garments to glide on a thin film of water.

IntenseWash
Uses 2 pumps allowing for energy efficiency and wash performance in less time. Detergent dissolves faster and sprays into the center of the load.



Auto Load Recognition
Weighs the clothes and you program the water and degree of soiling, allowing the right amount of detergent at the right time, to get the right result!

TwinDos | 2 Phase system
UltraPhase 1 Detergent & UltraPhase 2 Oxygen Bleach automatically dispenses from integrated cartridges that lasts up to 45 loads and saves approximately 30% in detergent costs.



Original Sensitive Refresh Elixir



ProfiEco Motor
BLPM – Brushless Permanent Magnet Motor 1600 RPM extremely energy efficient, maintenance free due to brushless motor, quiet.



Miele@Moblie app
Android and iOS, remote control w/ SmartStart Notification for TwinDos fill level, machine status, Assistat to select the most suitable program.



Rotary Iron



B 990 \$3,239

3 Heating elements for optimum heat distribution. High contact pressure for better removal of creases against ironing by hand. Practical swing-out bar for laundry. 83cm wide roller giving you five times wider space than a conventional iron. Relaxed method of ironing with an ergonomic seated position reduces strain on your back and keeps both hands free.



Ergonomic Seated Position



High Pressure Contact



Automatic finger Guard

Miele market research surveyed our customers and discovered that 95% of all buyers of a Miele rotary iron are satisfied, to very satisfied.



3 Heating Elements



Perfect Solutions for your industry

[Go to overview](#)



Hospitality

Hotels and bed & breakfast, restaurants, spa, wellness and sports



Care and Education

Nursing homes, education and childcare

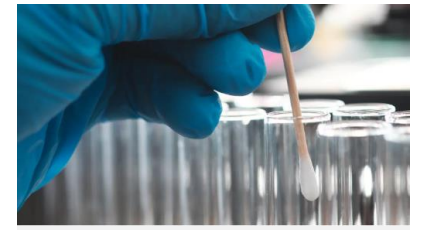

Laboratories

Small and large laboratories



Medical and Dental

Hospitals and surgeries, dentists, vets and animal care



Small businesses and Services

Offices, agencies, small businesses, contract cleaners, laundries and dry cleaners



Others

Residential, sports, emergency services equestrian, offshore and marine



Countertop Coffee Machines



CM 5310 OBSW \$1,849.99
Obsidian Black



CM 5510 RGP \$2,049.99
Obsidian Black/Rose Gold Pearl



CM 7750 OBSW \$5,999.99
Obsidian Black



Countertop coffee machine
With CoffeeSelect and
AutoDescal for maximum
flexibility



Miele coffee beans are organically grown from the Arabica shrub and harvested in the highlands of south America. The beans are sourced from a fair-trade certified organic coffee cooperative, and then roasted and blended exclusively for Miele by a private German roaster.

Available for purchase on 'Shop' Miele.ca
Black Edition: Café Crema, Espresso, Decaf, One For All.



CM 6160 OBSW \$2,599.99
Obsidian Black

NEW COLOUR



CM 6360 LOCM \$2,999.99
Lotus White/CleanSteel



CM 6360 OBBP \$2,999.99
Obsidian Black/BronzePearl



CM 6360 OBCM \$2,999.99
Obsidian Black/CleanSteel

FloorCare

Miele Triflex HX2 cordless stick vacuum cleaner



Dust, meet our most powerful vacuum cleaner.

Engineered in Germany. Made in Germany.

Scout RX3 Home Vision HD



Robot vacuum cleaner with live image feed and 2 hours runtime with the best cleaning performance.

Boost CX1 series



Boost CX1 Series is compact, powerful and easy to handle an, it can be used even in small spaces, thanks to its compact dimensions and maneuverability. At the same time, the large TrackDrive side wheels allow it to be parked safely on stairs and protect it from bumping into furniture and door frames. And the Boost CX1 does not compromise when it comes to cleaning performance, as it works with a highly efficient three-stage filter system: the easy-to-empty dust container for coarser particles, a washable fine dust filter, and a replaceable exhaust air filter.



Miele Limited Headquarters
Project Business Division

161 Four Valley Drive
Vaughan, ON Canada L4K 4V8

Phone 1 800 643 5381

The information contained in these documents is confidential, privileged and only for the information of the intended recipient and may not be used, published or redistributed without the prior written consent of Miele & Cie. KG. The opinions expressed are in good faith and while every care has been taken in preparing these documents, Miele employees and managers make no representation and gives no warranties of whatever nature in respect of these documents, including but not limited to the accuracy or completeness of any information, facts and/or opinions contained therein. Miele & Cie. KG, its subsidiaries, the directors, employees and agents cannot be held liable for the use of and reliance of the opinions, estimates, forecasts and findings in these documents.